

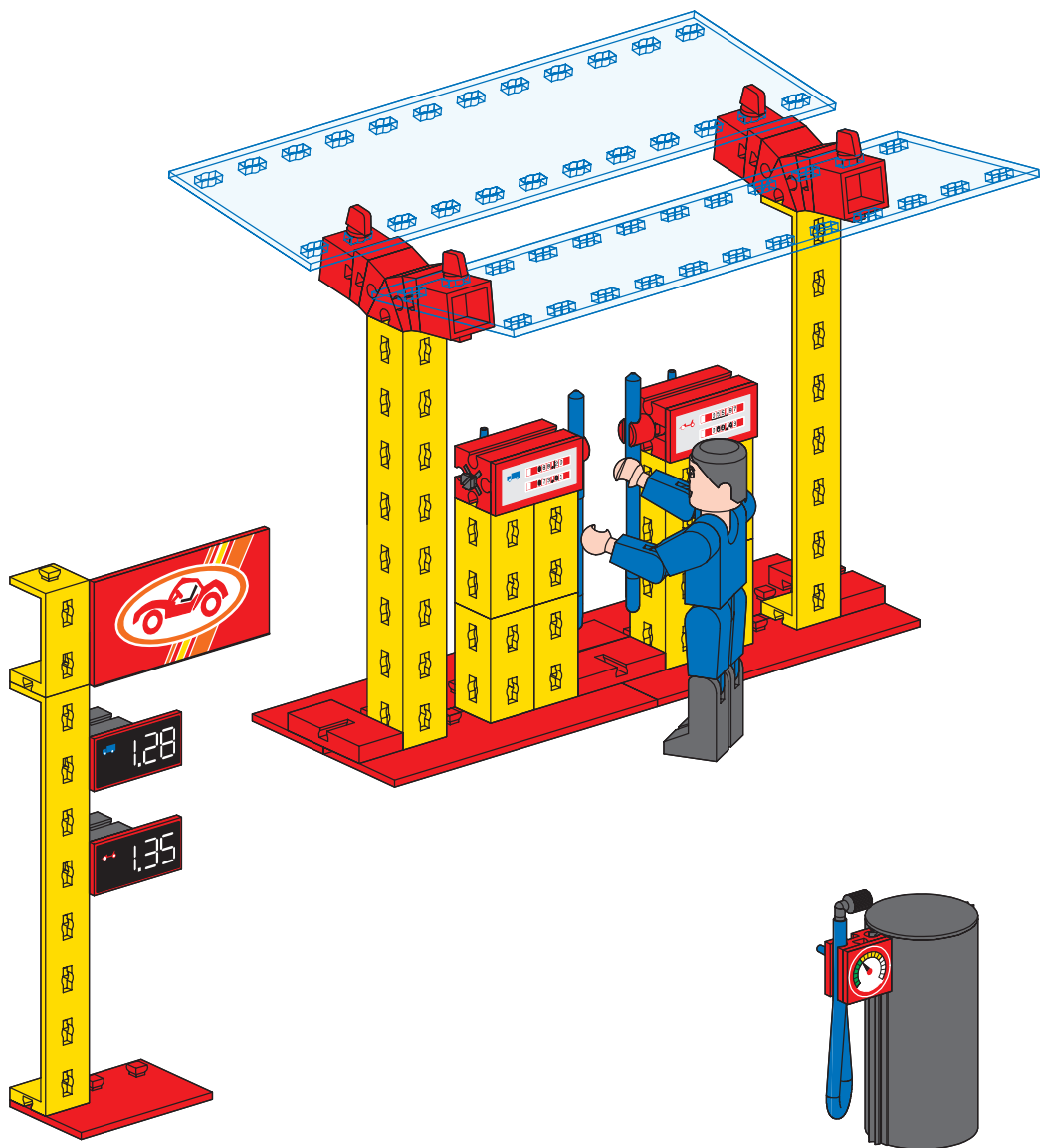









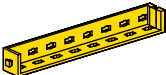







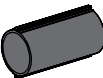
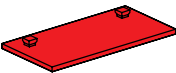

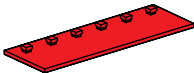

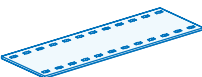

# SERVICE STATION

fischertechnik 

BASIC



	31 010 2 x		36 294 3 x		38 241 4 x
	31 632 2 x		36 299 9 x		38 246 1 x
	31 642 3 x		36 323 4 x		38 248 1 x
	31 981 4 x		36 702 1 x		38 249 1 x
	32 071 4 x		36 703 1 x		38 251 4 x
	32 850 3 x		36 817 2 x		38 428 4 x
	32 853 1 x		36 915 1 x		116 251 2 x
	35 980 2 x		36 973 4 x		126 976 1 x
			37 468 1 x		127 298 1 x

- Alle Einzelteile, insbesondere bewegliche Teile sind falls notwendig zu warten und zu reinigen.
- All components, especially moving parts, should be maintained and cleaned as necessary.
- Toutes les pièces détachées et en particulier les pièces mobiles, sont, si nécessaire, à entretenir et à nettoyer.
- Alle onderdelen, vooral de bewegende delen, kunnen, indien noodzakelijk, onderhouden en gereinigd worden.
- Es necesario limpiar y mantener en buen estado todas las diferentes piezas - especialmente las piezas móviles.
- Caso necessário, todas as peças individuais, especialmente peças móveis, tem que ser submetidas à manutenção e ser limpas.
- Se necessario, tutti i singoli componenti, soprattutto le parti mobili, si devono eventualmente sottoporre a manutenzione e pulizia.
- Все детали, особенно подвижные, требуют ухода и чистки.
- 必要时应保养和清洁所有零件，尤指运动部件。

3 x 10 cm

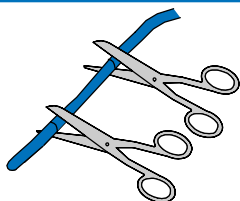

0

5 cm

10 cm

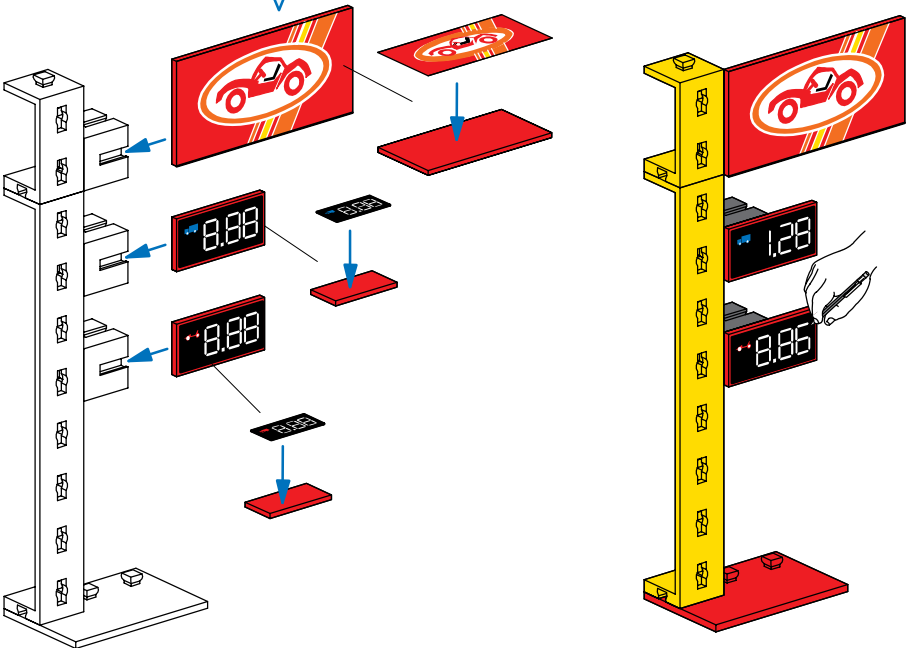
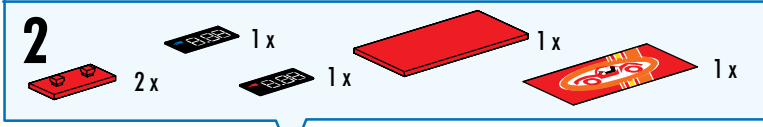
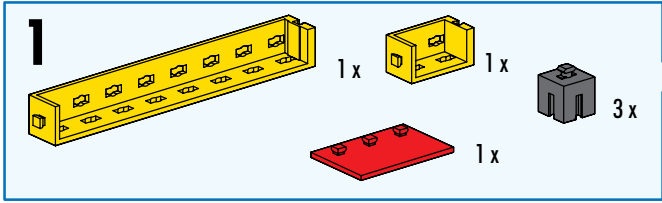
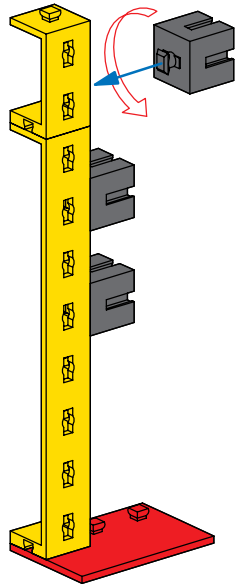
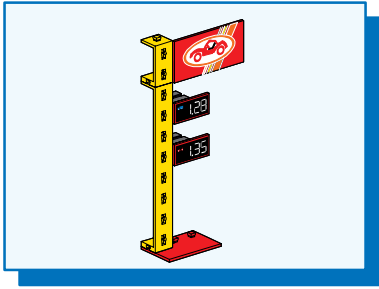

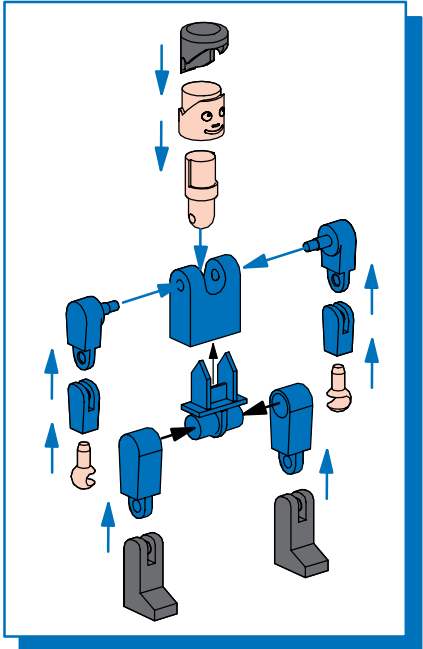
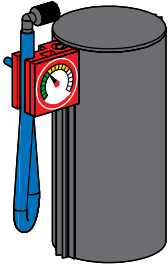
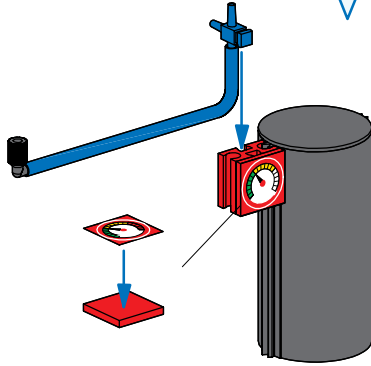
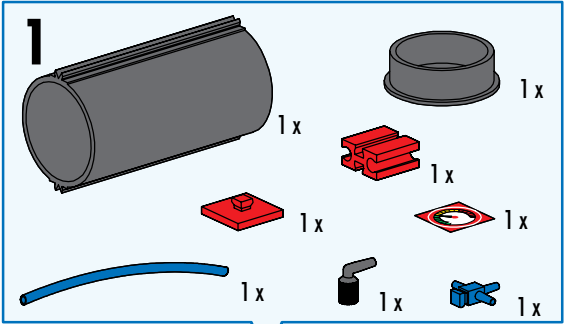
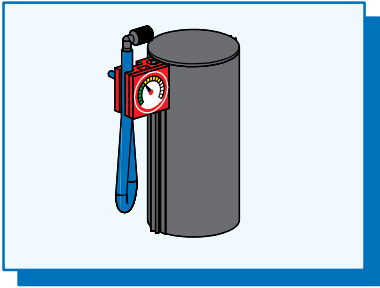

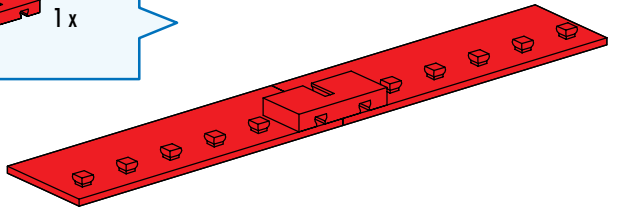
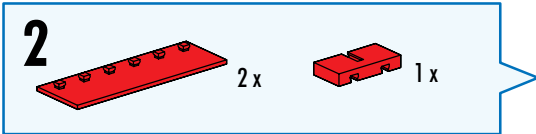
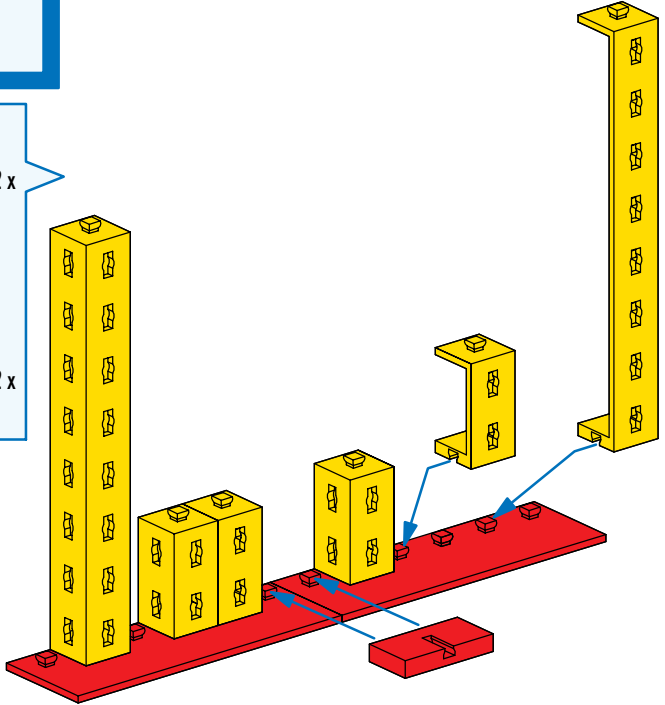
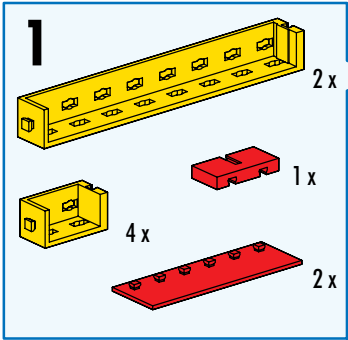
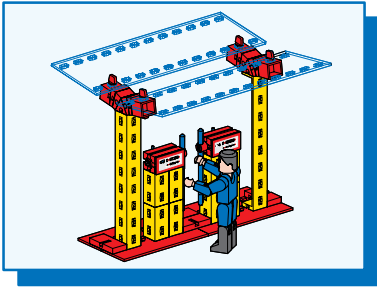

- 3**
- 60° 2 x
  - 15° 4 x
  - 4 x
  - 2 x

**2**

- 4**
- 2 x
  - 2 x
  - 2 x

**2 x**

- 5**
- 2 x
  - 4 x
  - 2 x
  - 7,5° 4 x

**4**

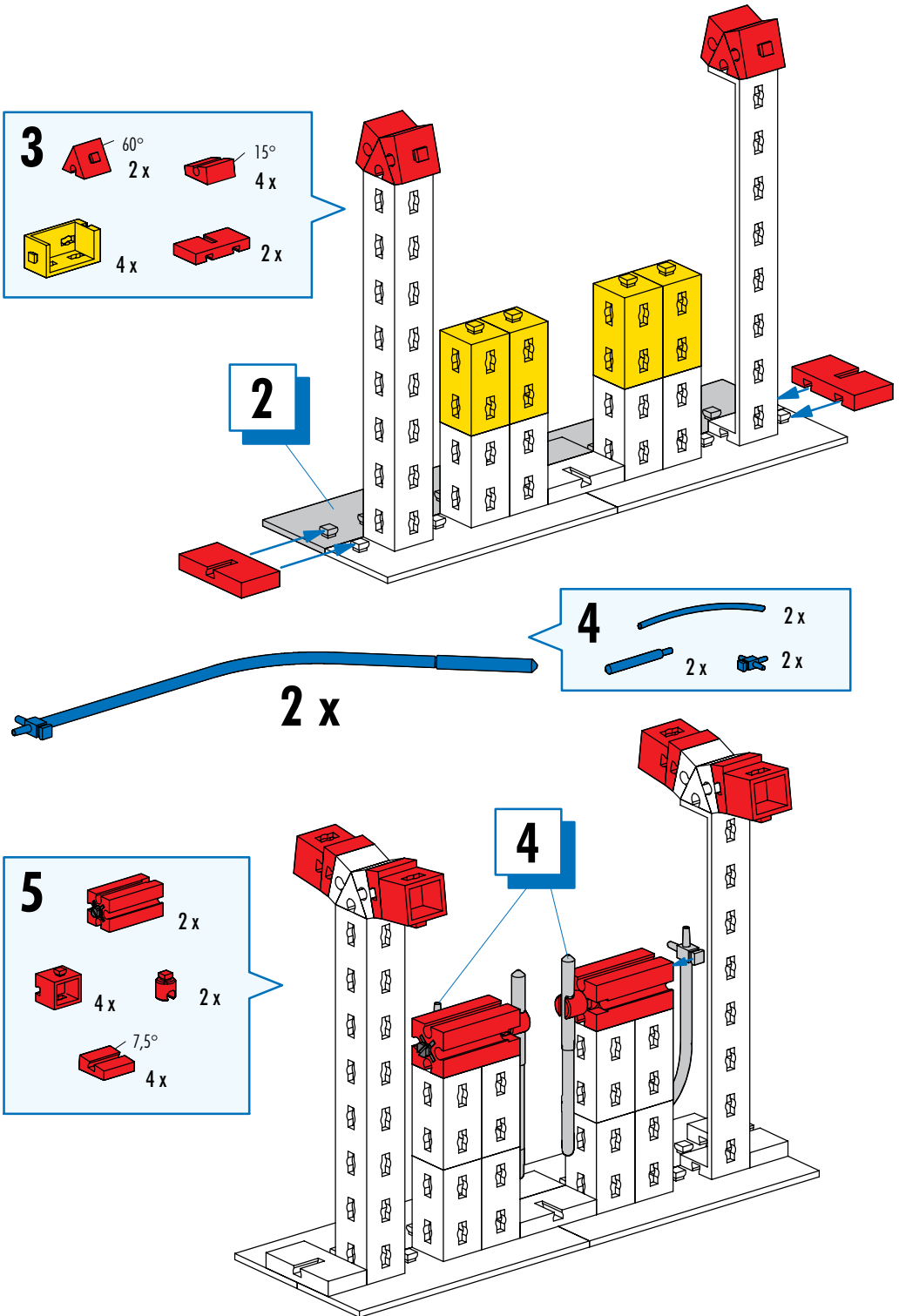

6

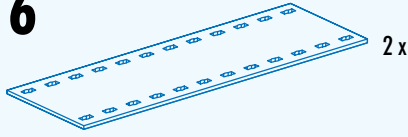

1x  1x 

4  4x  2x

