

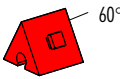

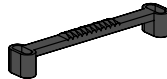









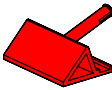
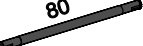

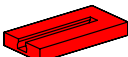

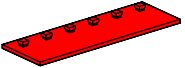

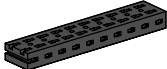
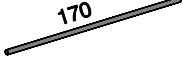



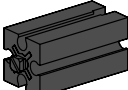
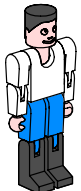

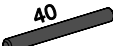

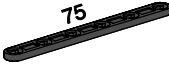



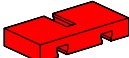









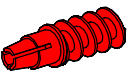

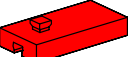





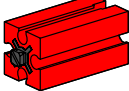

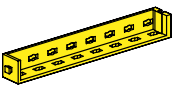





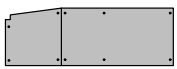

Einzelteilübersicht
Spare parts list
Liste des pièces détachées

Onderdelenoverzicht
Lista da piezas
Resumo de peça individual

	31 010 4x		32 229 1x		35 113 1x		36 573 8x		38 246 2x
	31 036 1x		32 230 1x		35 405 1x		36 581 4x		38 248 2x
	31 060 6x		32 330 2x		35 668 4x		36 819 1x		38 251 6x
	31 436 2x		32 854 2x		35 696 1x		36 914 2x		38 413 1x
	31 597 4x		32 879 6x		35 806 1x		36 919 2x		38 414 2x
	31 670 4x		32 881 6x				36 923 2x		38 423 5x
	31 848 6x		32 882 1x		35 945 1x		36 973 4x		38 428 1x
	31 850 1x		32 985 2x		35 973 1x		37 237 5x		38 464 2x
	31 915 1x		34 994 4x		35 975 2x		37 468 2x		38 538 2x
	31 916 1x		34 995 4x		35 977 1x		37 858 2x		38 543 6x
	31 978 1x		35 049 4x		35 980 1x		37 925 2x		38 545 2x
	31 982 5x		35 053 8x		36 248 72x		37 926 4x		116251 2x
	31 983 3x		35 061 2x		36 294 9x		38 225 1x		124 802 10x
	31 984 1x		35 063 1x		36 299 9x		38 240 9x		128 029 1x
	32 064 8x		35 073 2x		36 323 28x		38 241 4x		128 053 1x
	32 071 2x		35 088 1x		36 334 6x		38 242 2x		
	32 228 2x		35 112 3x		36 370 1x		38 244 3x		

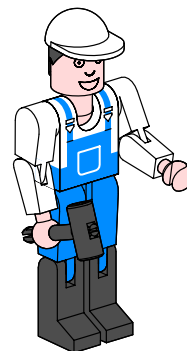
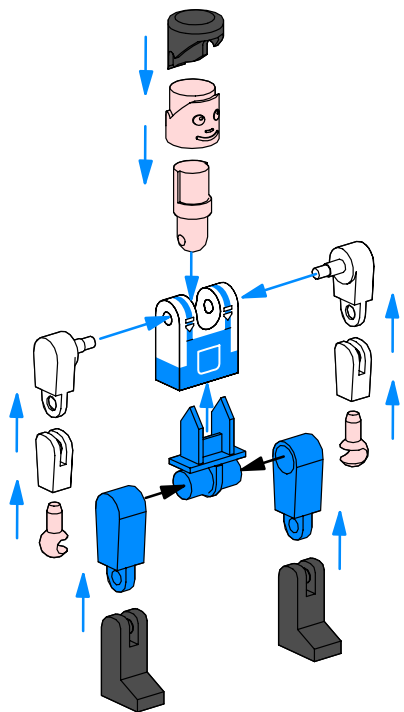
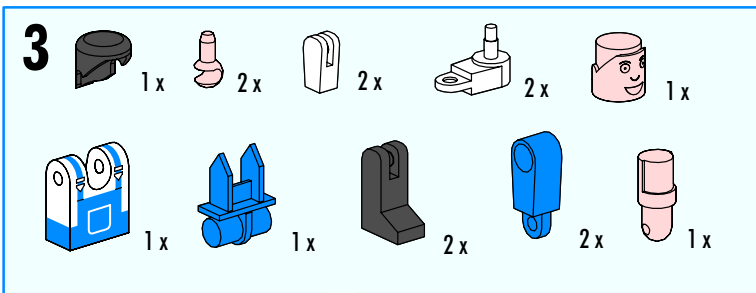
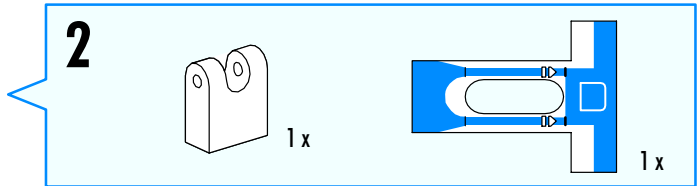
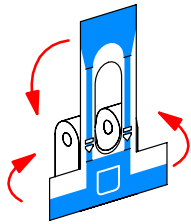
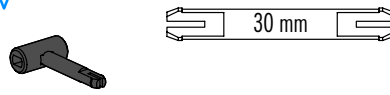
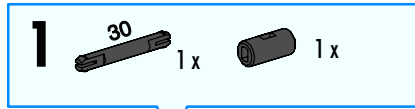
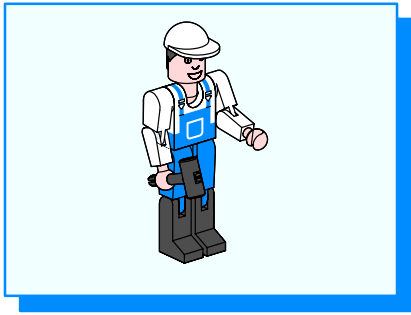

■ Alle Einzelteile, insbesondere bewegliche Teile sind falls notwendig zu warten und zu reinigen.
 ■ All components, especially moving parts, should be maintained and cleaned as necessary.
 ■ Toutes les pièces détachées et en particulier les pièces mobiles, sont, si nécessaire, à entretenir et à nettoyer.

■ Alle onderdelen, vooral de bewegende delen, kunnen, indien noodzakelijk, onderhouden en gereinig worden.
 ■ Es necesario limpiar y mantener en buen estado todas las diferentes piezas - especialmente las piezas móviles.
 ■ Caso necessário, todas as peças individuais, especialmente peças móveis, tem que ser submetidas à manutenção e ser limpas.

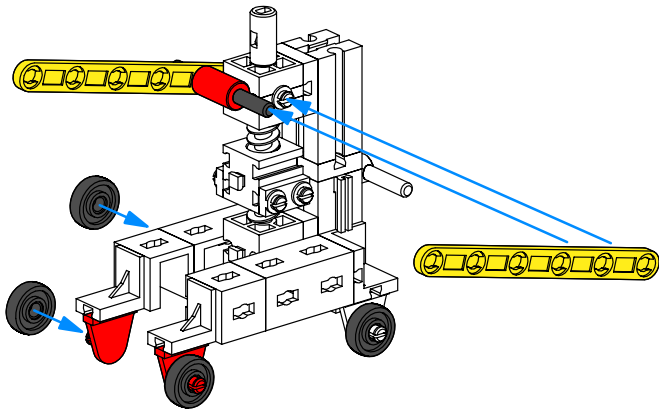

8

- 75 2 x
- 40 1 x
- Red bush 1 x
- Red hook 2 x
- Black wheel 4 x

40 mm

9

- Red bush 2 x
- Red hook 1 x
- Black axle 30 1 x
- Yellow 30-hole beam 2 x
- Red gear 4 x

30 mm

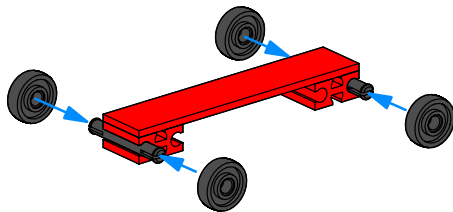
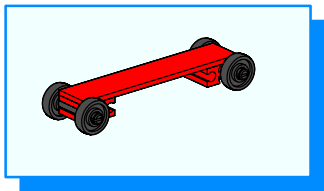
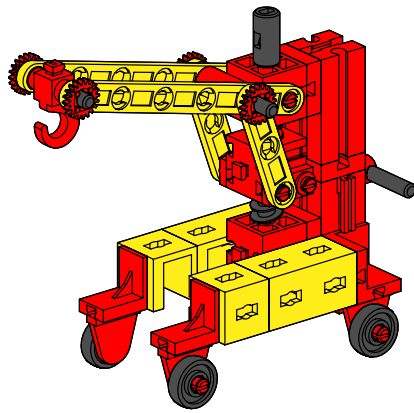
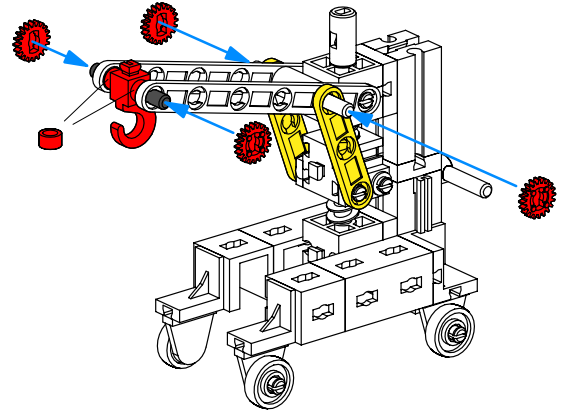

10

- Red 28-hole beam 1 x
- Red axle 2 x
- Black wheel 4 x

28 mm

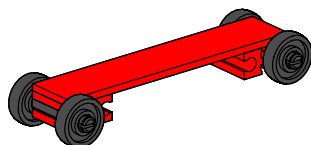

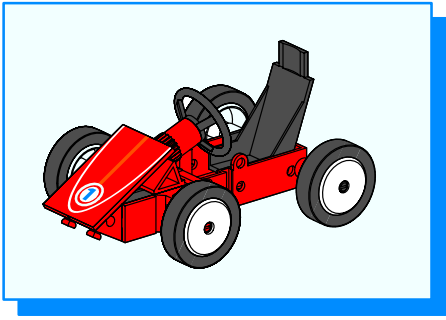

11

1x [Red 1x4 Technic Beam with 2 Holes]

2x [Red 1x2 Technic Pin]

2x [Red 1x2 Technic Pin]

2x [Red 1x2 Technic Pin]

1x [Red 1x2 Technic Pin]

1x [Red 1x2 Technic Pin]

1x [Red 1x2 Technic Pin]

2x [Red 1x2 Technic Pin]

2x [Red 1x2 Technic Pin]

1x [Red 1x2 Technic Pin]

1x [Red 1x2 Technic Pin]

80

1x [Red 1x2 Technic Pin]

80 mm

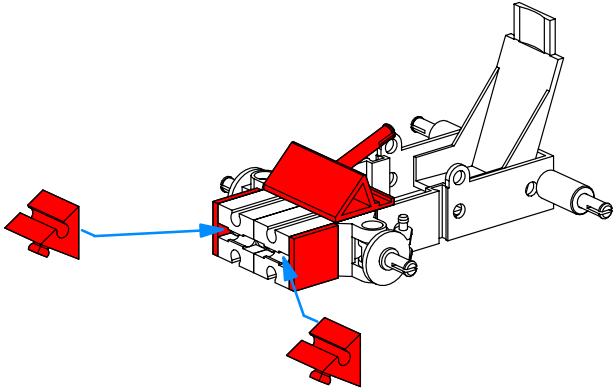
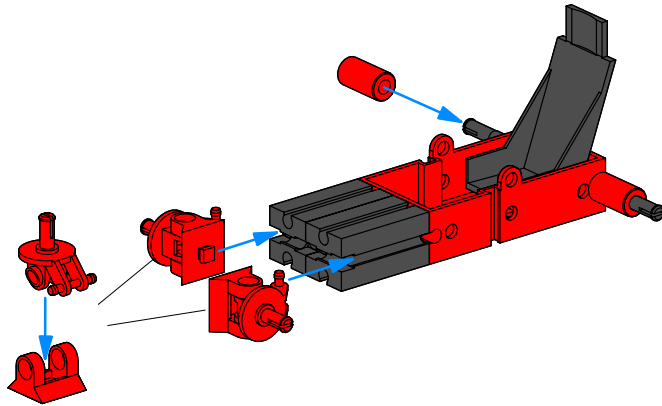

12

2x [Red 60° Technic Pin]

1x [Red 1x2 Technic Pin]

2x [Red 1x2 Technic Pin]

13

1x [Red 1x2 Technic Pin]

1x [Red 1x2 Technic Pin]

2x [Red 1x2 Technic Pin]

4x [Red 1x2 Technic Pin]

4x [Red 1x2 Technic Pin]

1x [Red 1x2 Technic Pin]

1x [Red 1x2 Technic Pin]

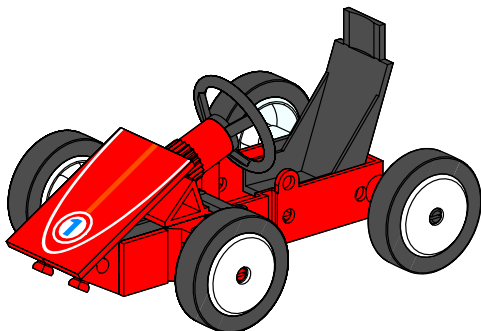
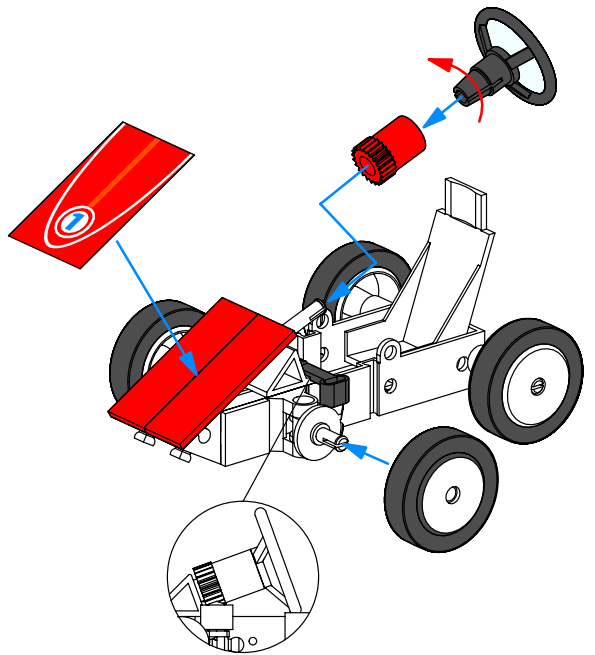

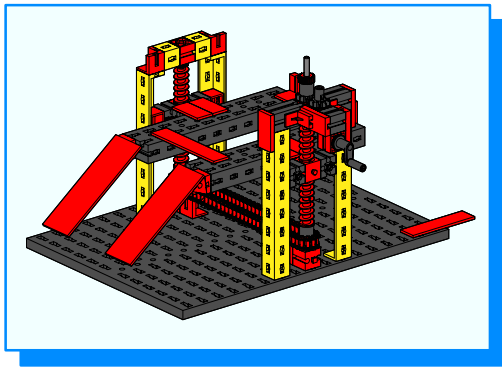

14

- 1 x [Black 17x17 Technic Plate]
- 2 x [Red 1x2 Technic Brick]
- 1 x [Grey Technic Pin 125]
- 1 x [Grey Technic Pin 170]
- 2 x [Red 1x3 Technic Beam]
- 2 x [Red 1x2 Technic Brick with Hole]

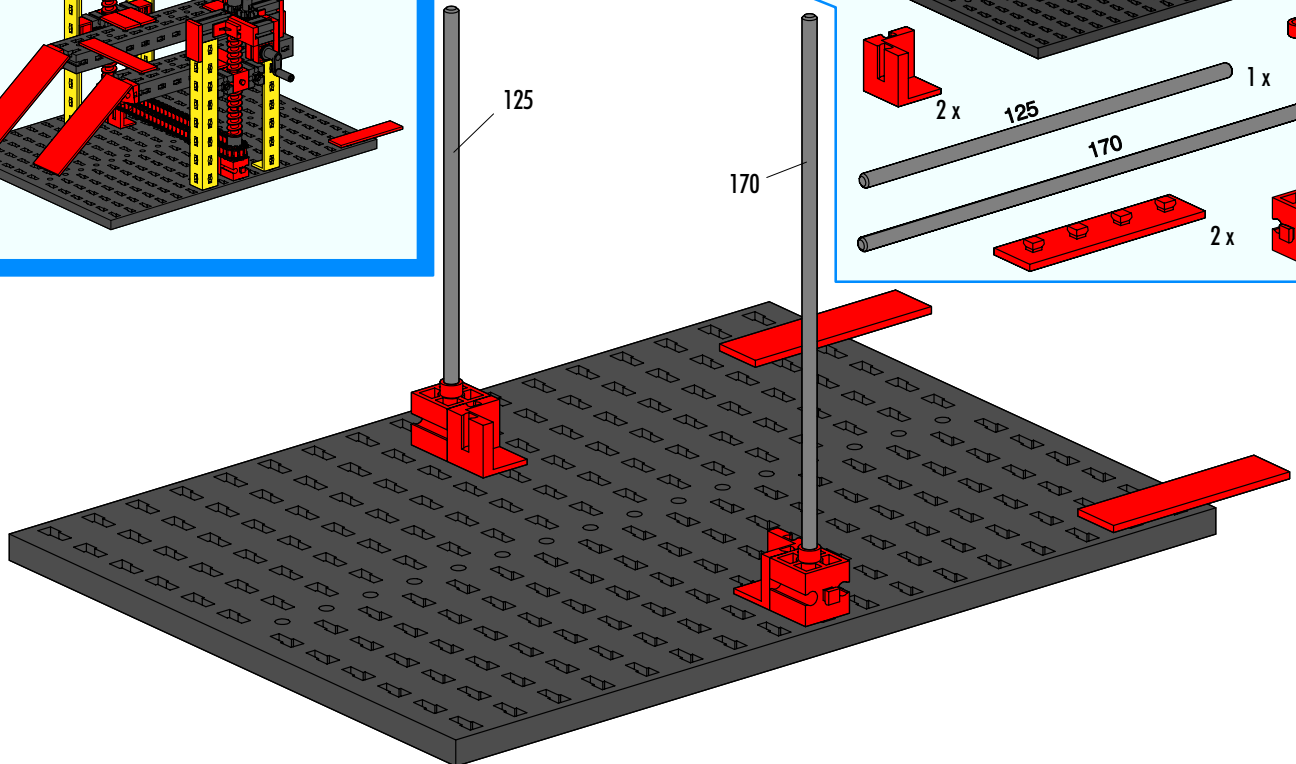

15

- 4 x [Grey Technic Pin 1/2]
- 4 x [Red 1x2 Technic Brick]
- 2 x [Red 1x3 Technic Beam]
- 4 x [Red 1x2 Technic Brick]

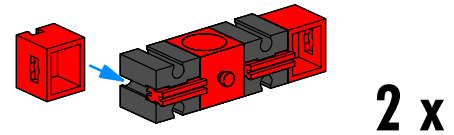

- Zahnrad festdrehen
- Tighten toothed gear
- Visser à fond la roue dentée
- Tandwiel vastdraaien
- Apretar a fondo la rueda dentada
- Aparafusar firmemente a roda tensora

15

16

- 2 x [Grey Technic Gear]
- 2 x [Red Technic Pin with Spring]
- 4 x [Red Technic Pin with Spring]

15

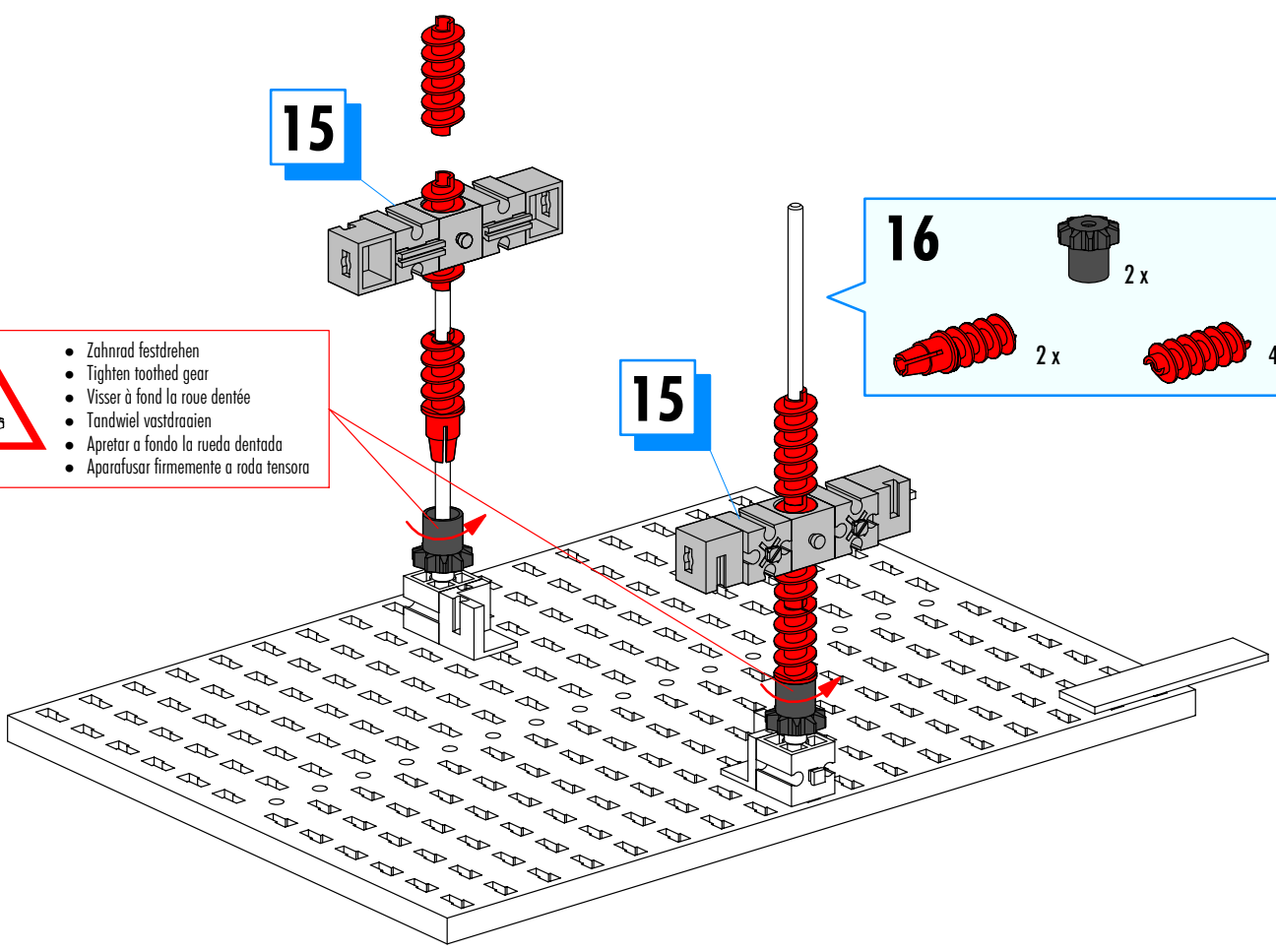

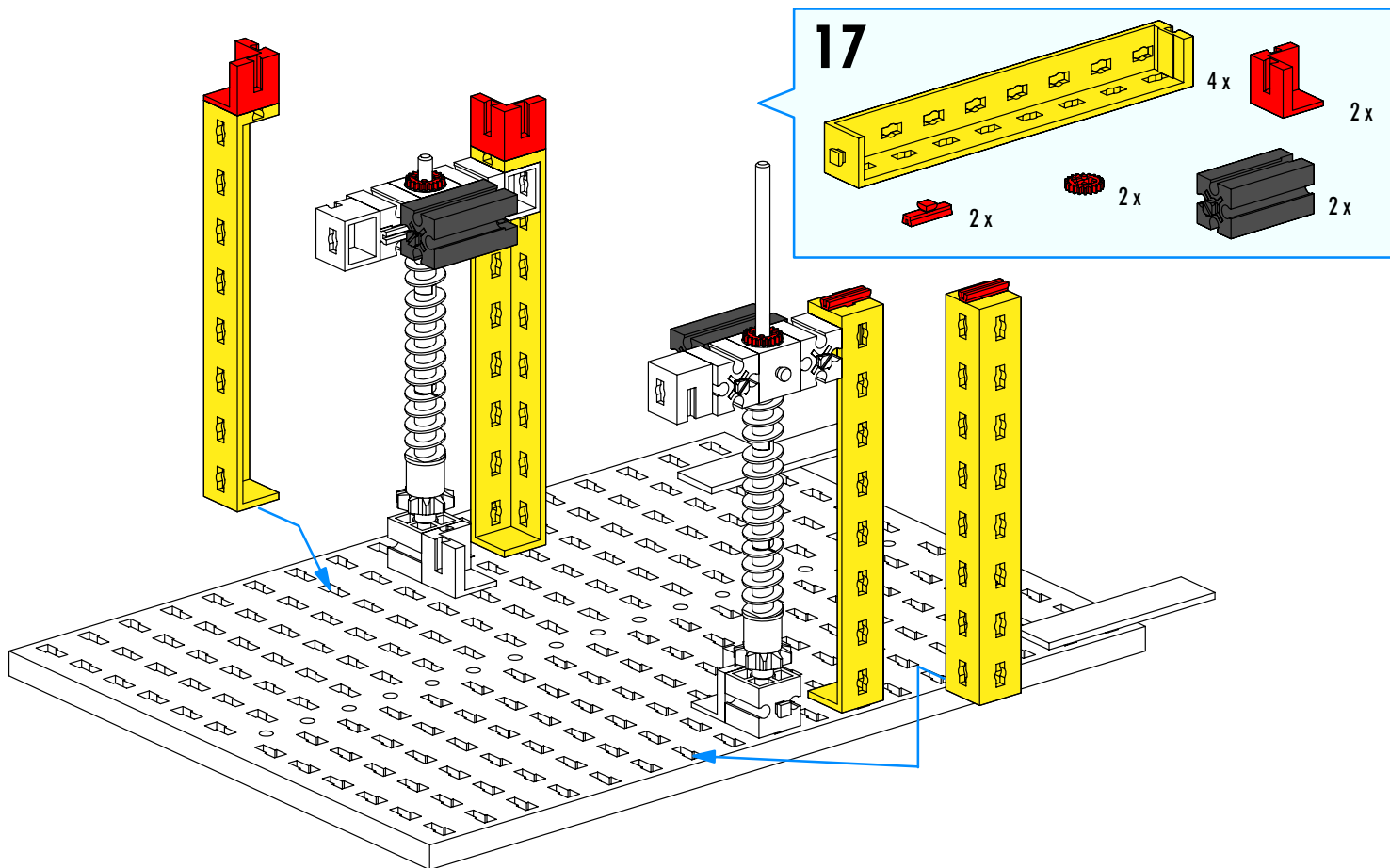

- Vor Einbau der Kette beide Führungen ganz nach oben drehen
- Before installing the chain, rotate both guides clear up to the top
- Tourner les deux guidages entièrement jusqu'en haut avant de procéder au montage de la chaîne
- Voor inbouw van de ketting eerst beide geleidingen helemaal naar boven draaien
- Antes de montar la cadena, girar ambas guías totalmente hacia arriba
- Antes da montagem da corrente, girar as duas guías bem para cima

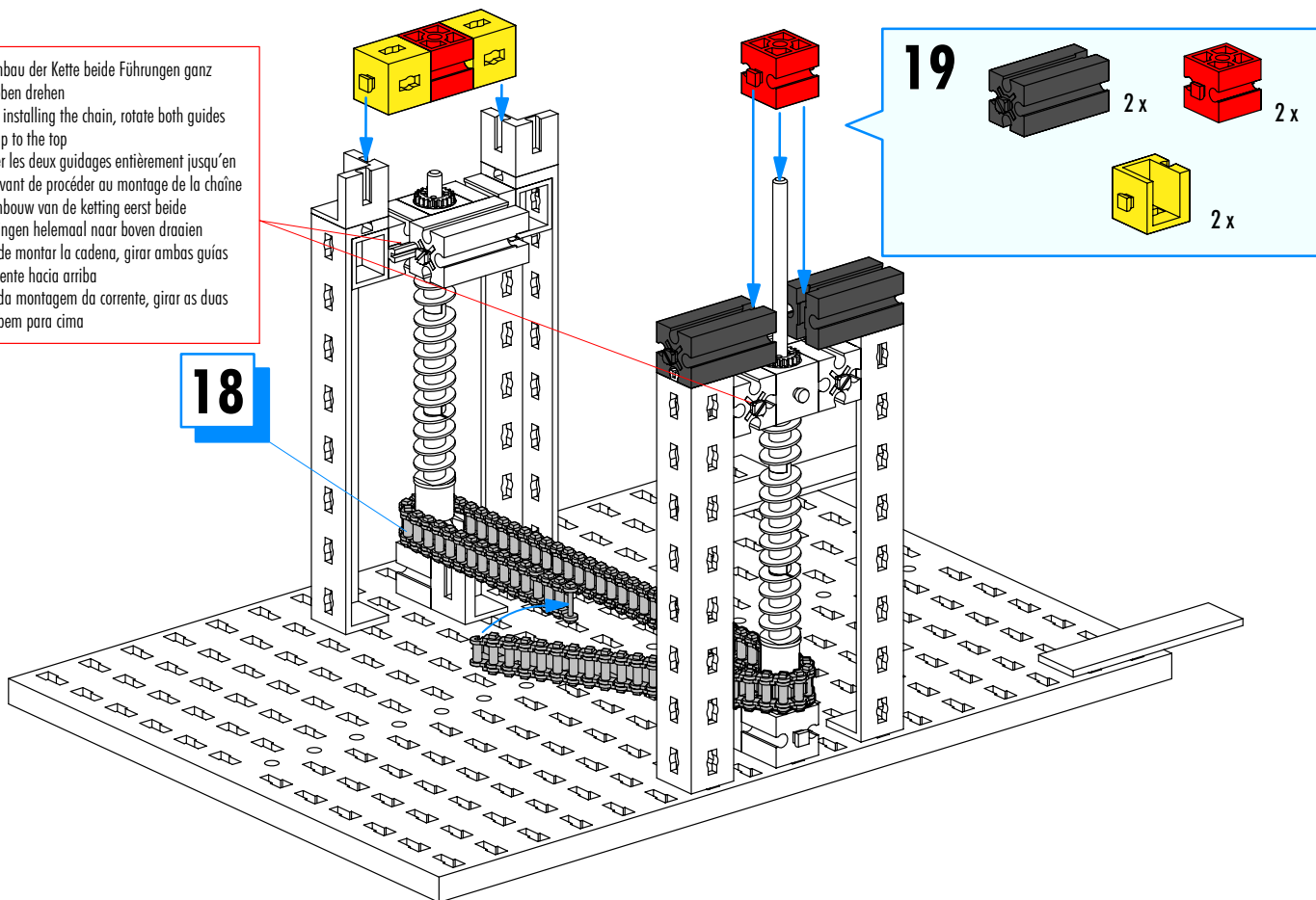

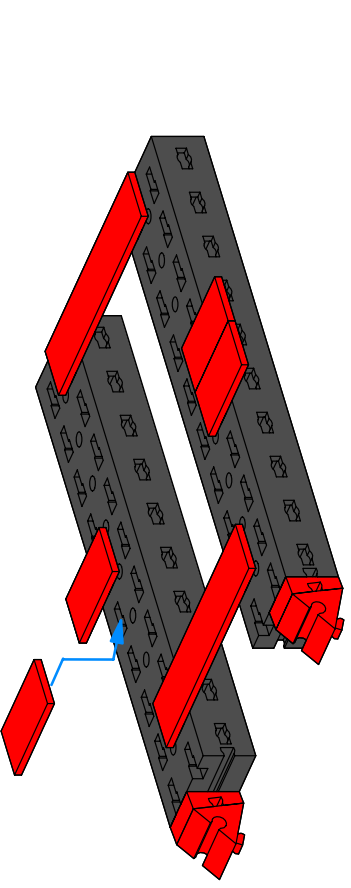
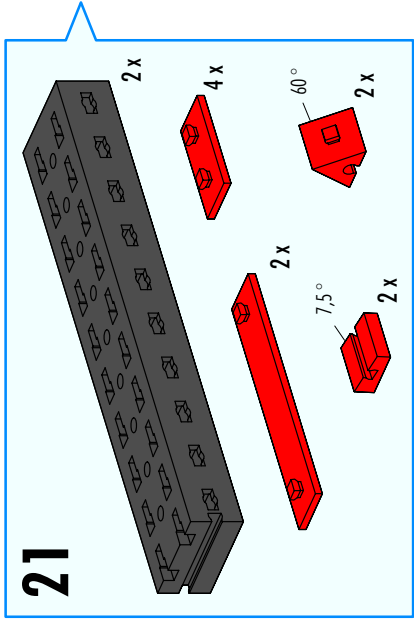
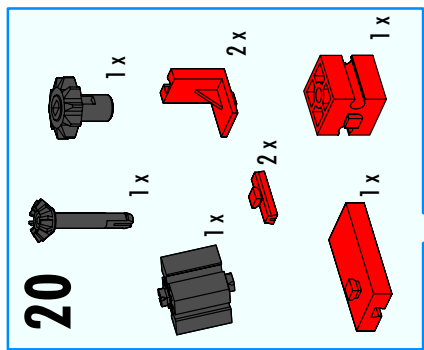

- Zahnrad festziehen
- Tighten toothed gear
- Visser à fond la roue dentée
- Tandwiel vastdraaien
- Apretar a fondo la rueda dentada
- Aparatar firmemente a roda tensora

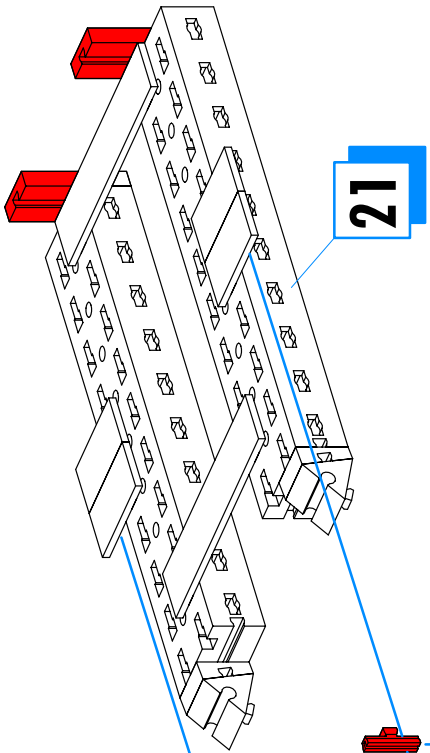
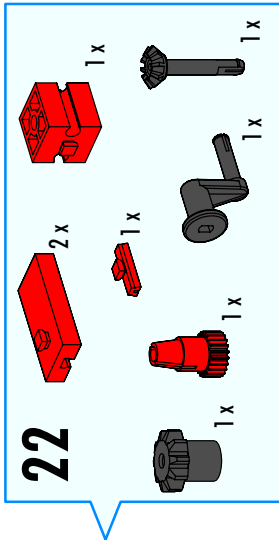
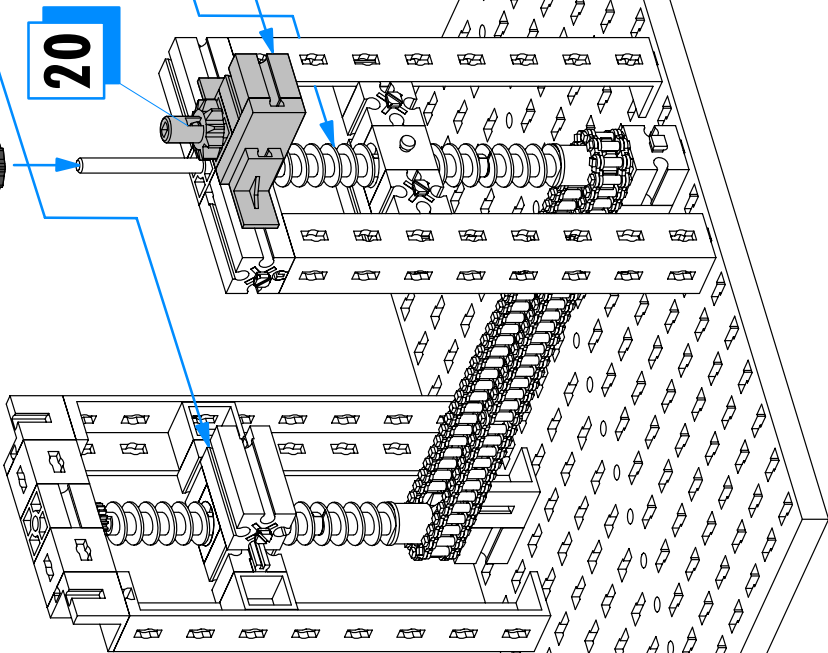
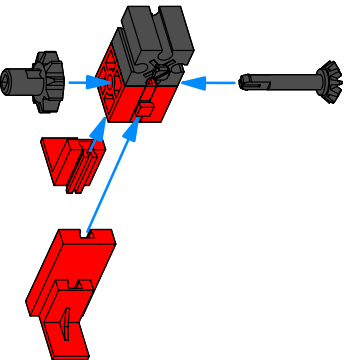

23

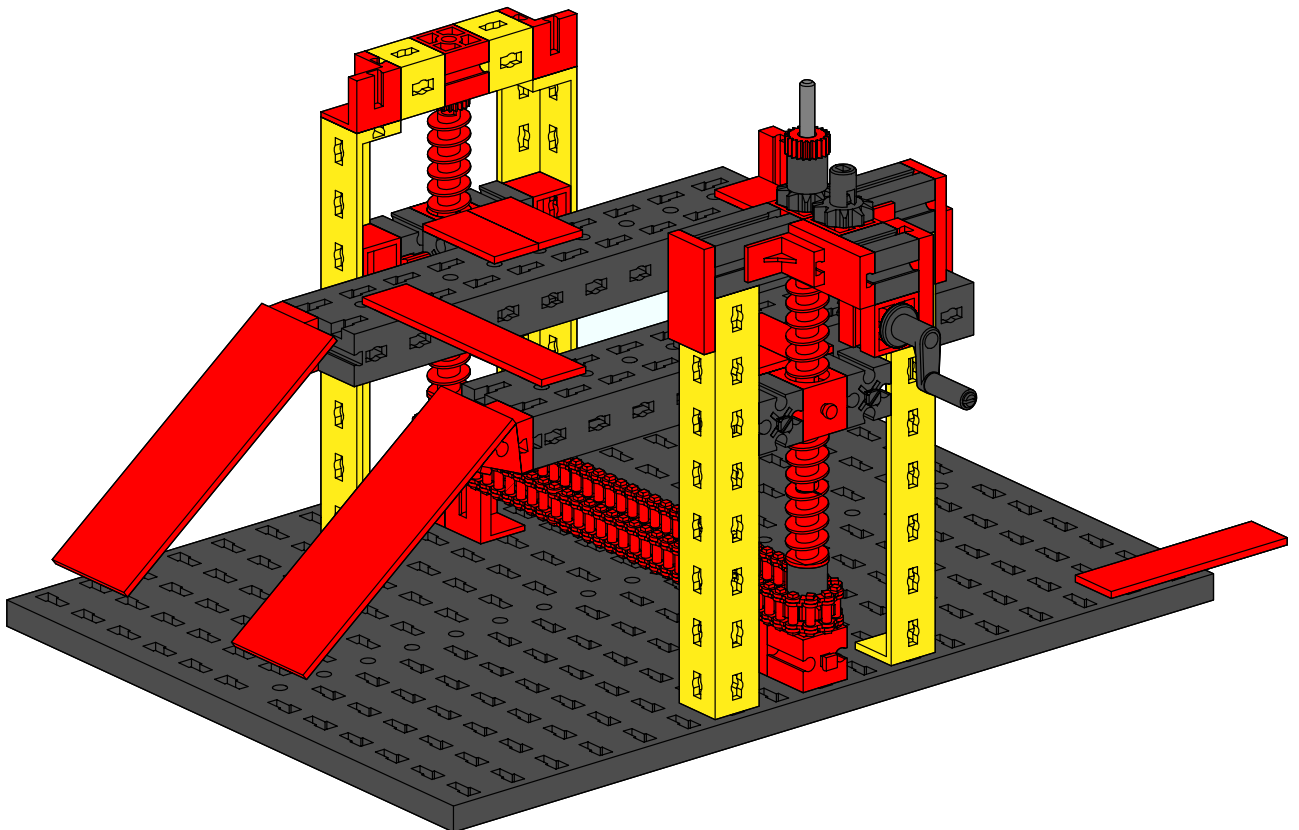
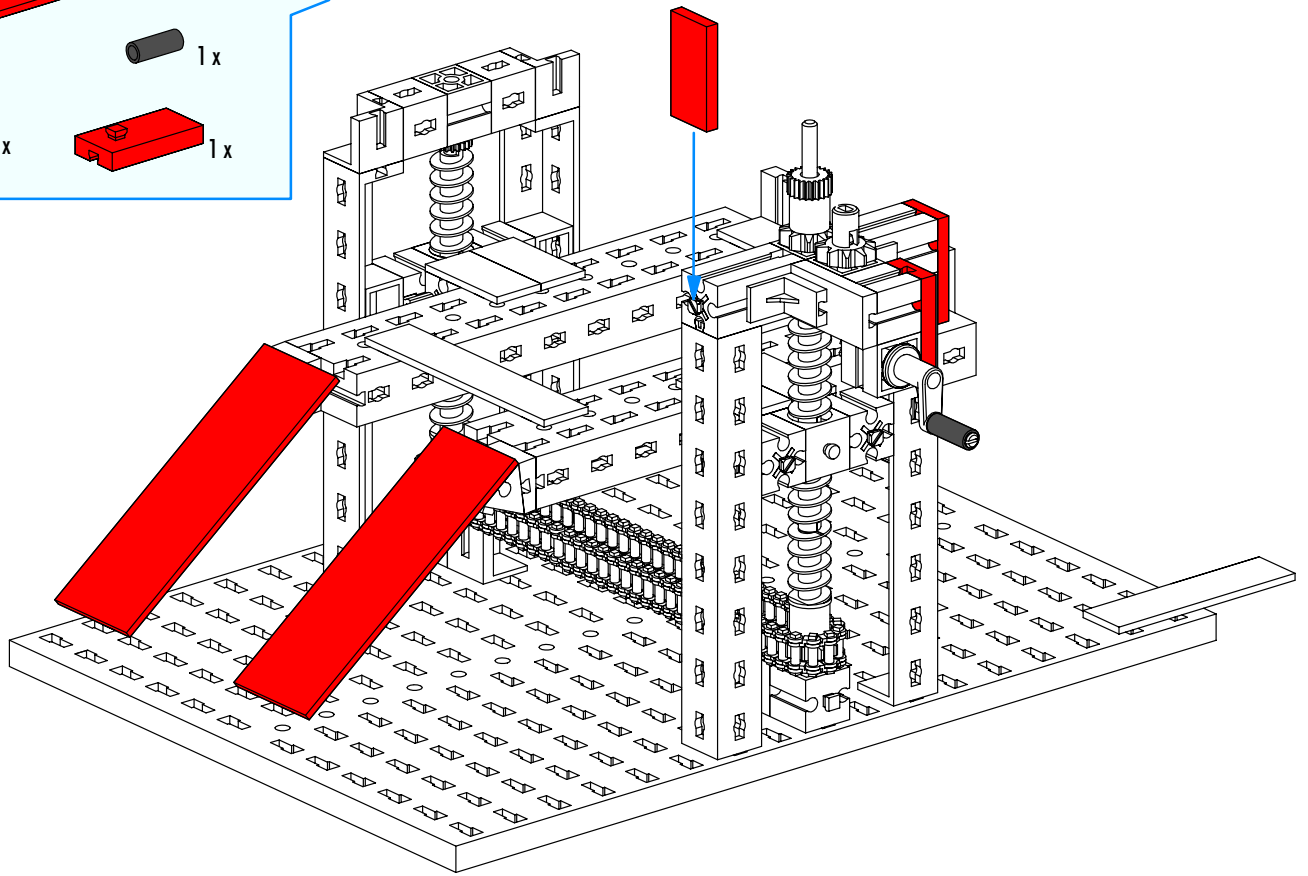
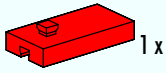
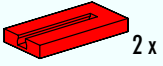
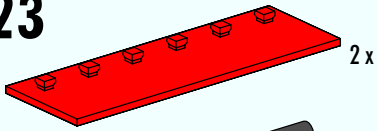

Motorisierung
Motorization
Motorisation

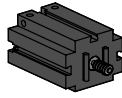

Motorising
Motorización
Motorização

Mini Motor
Set
30342

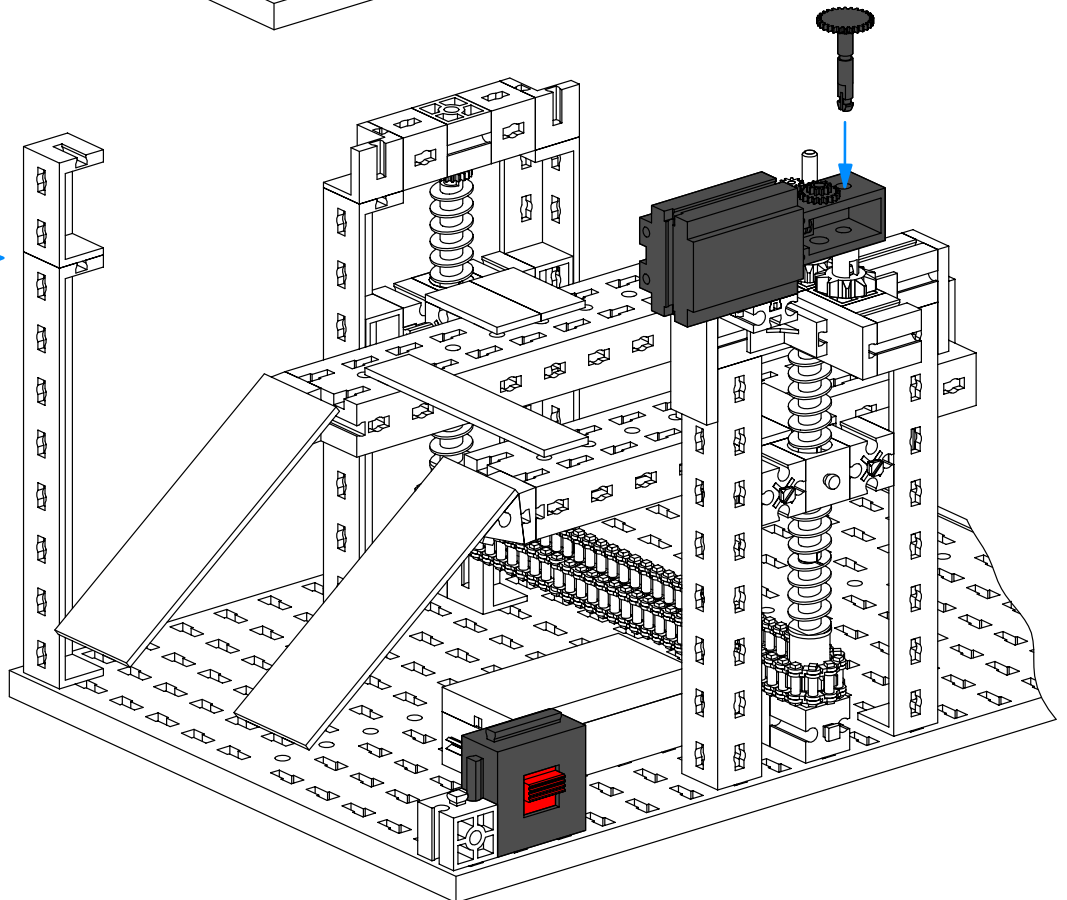
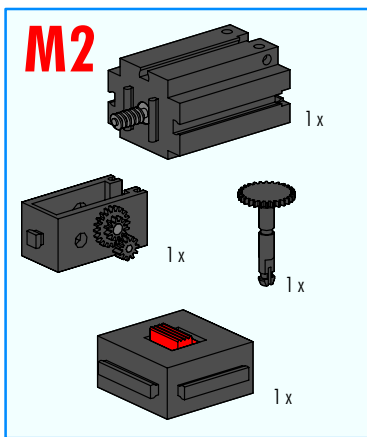
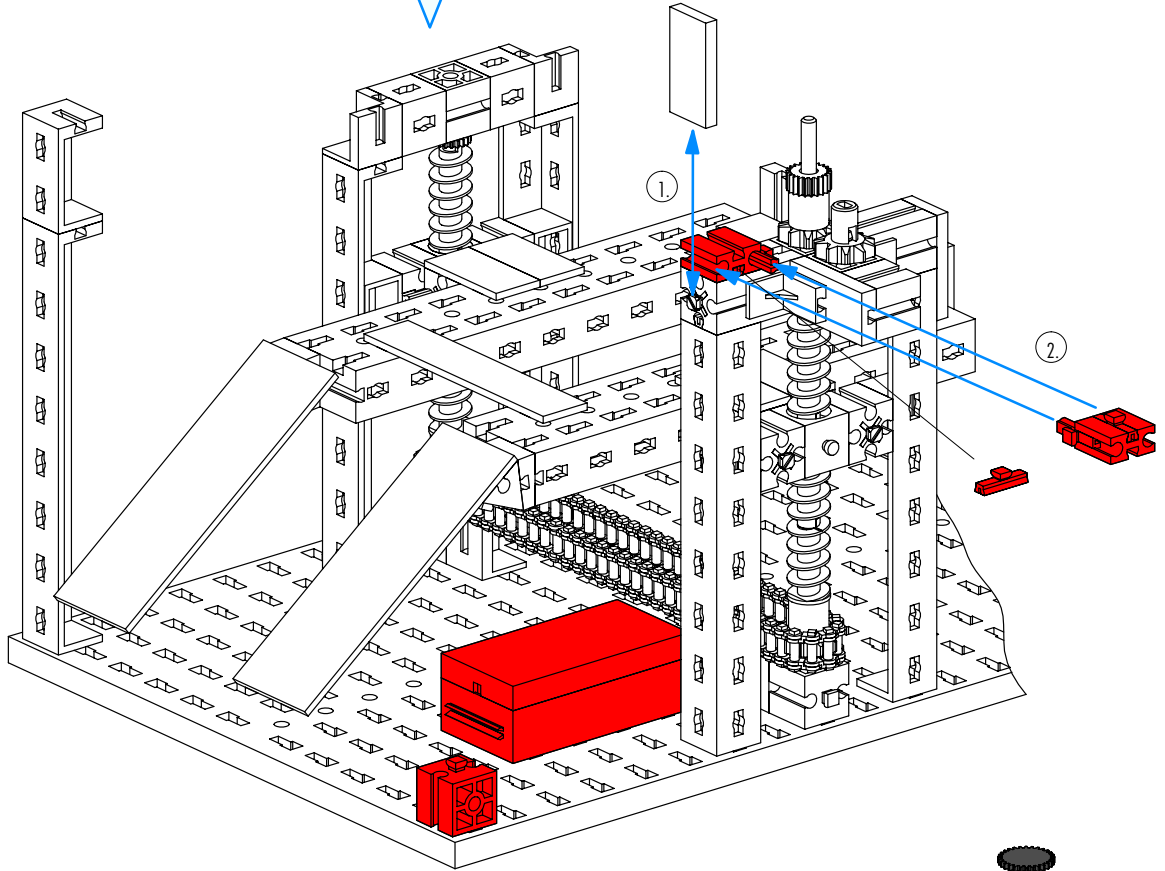
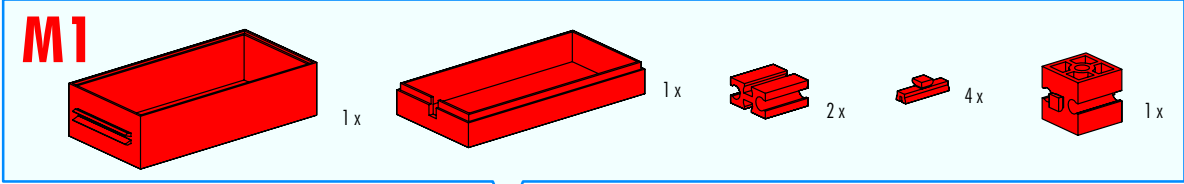

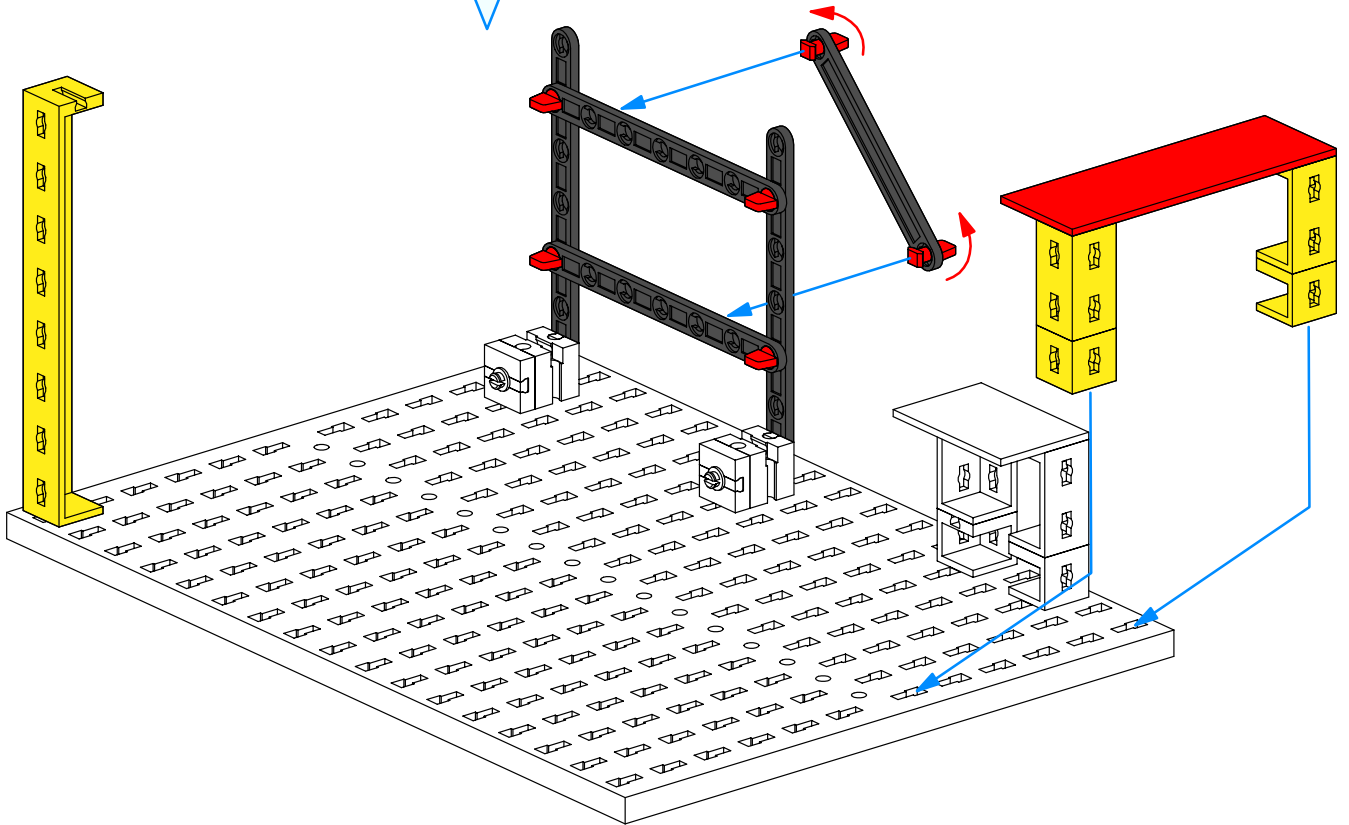
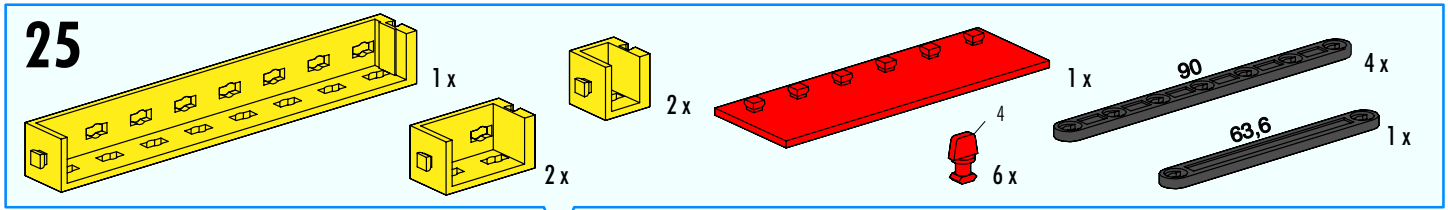
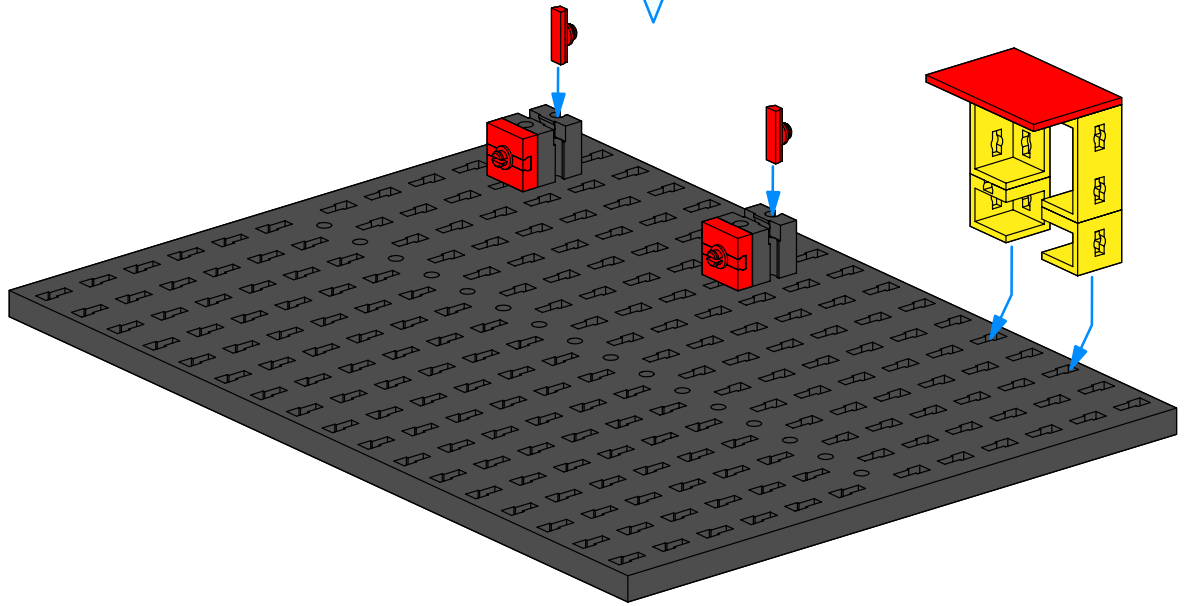
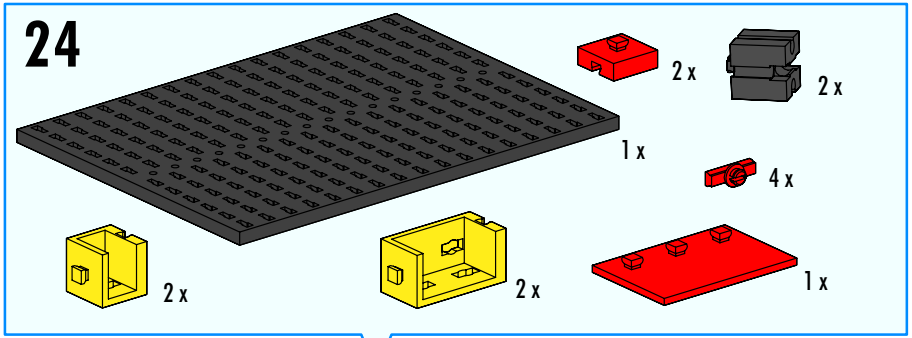
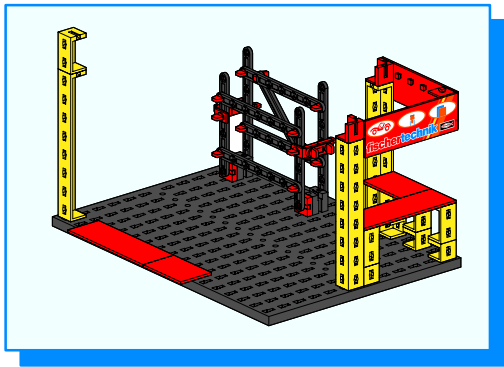

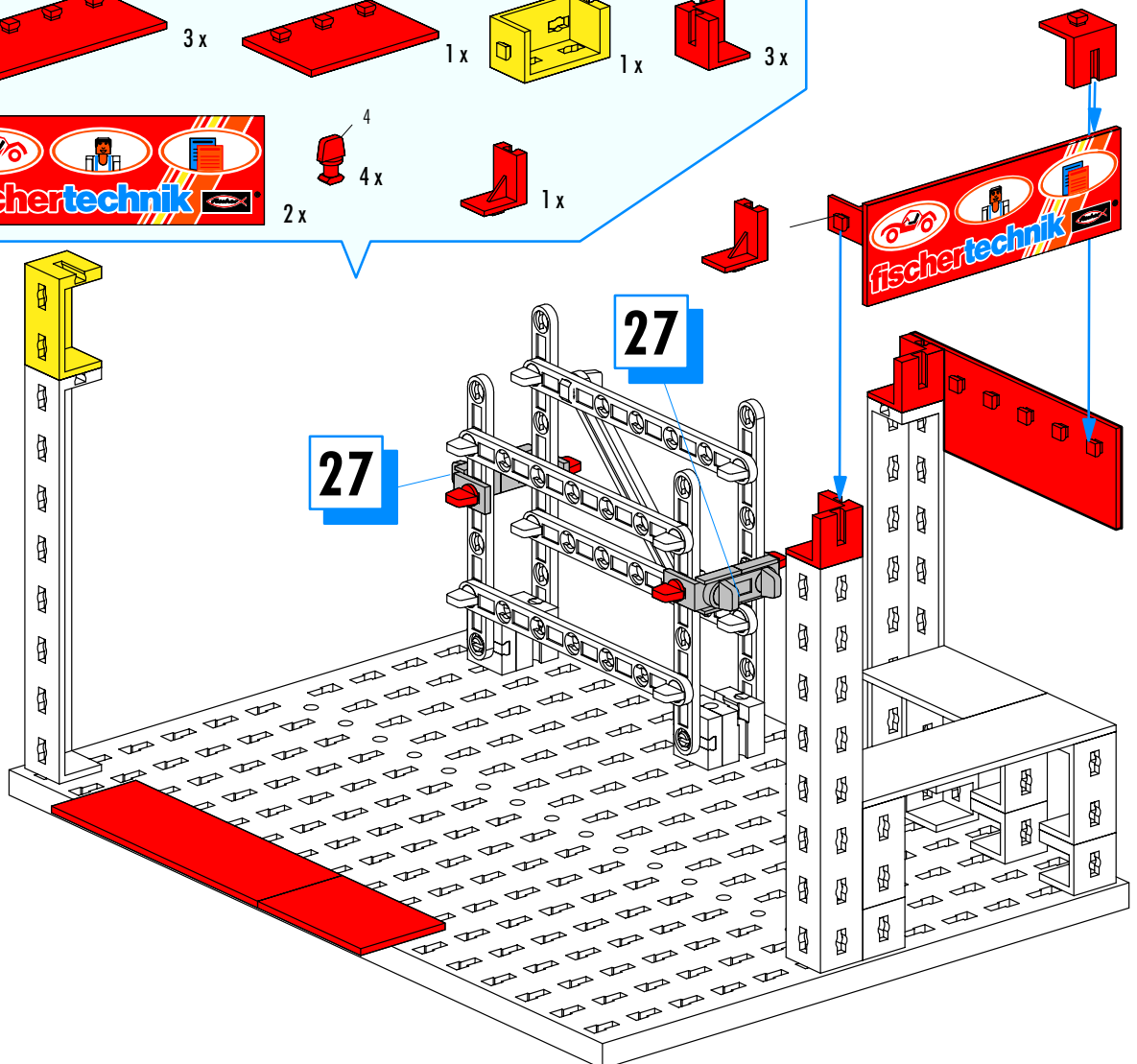
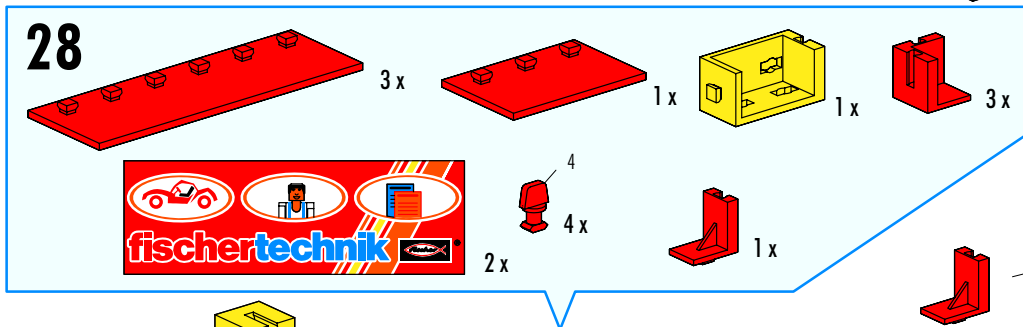
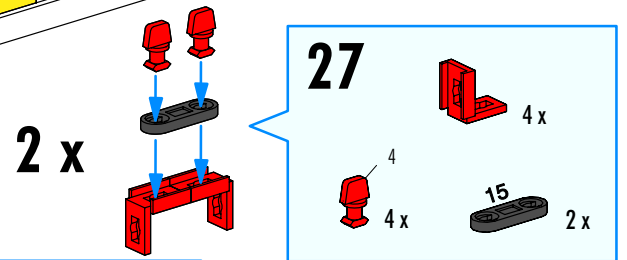
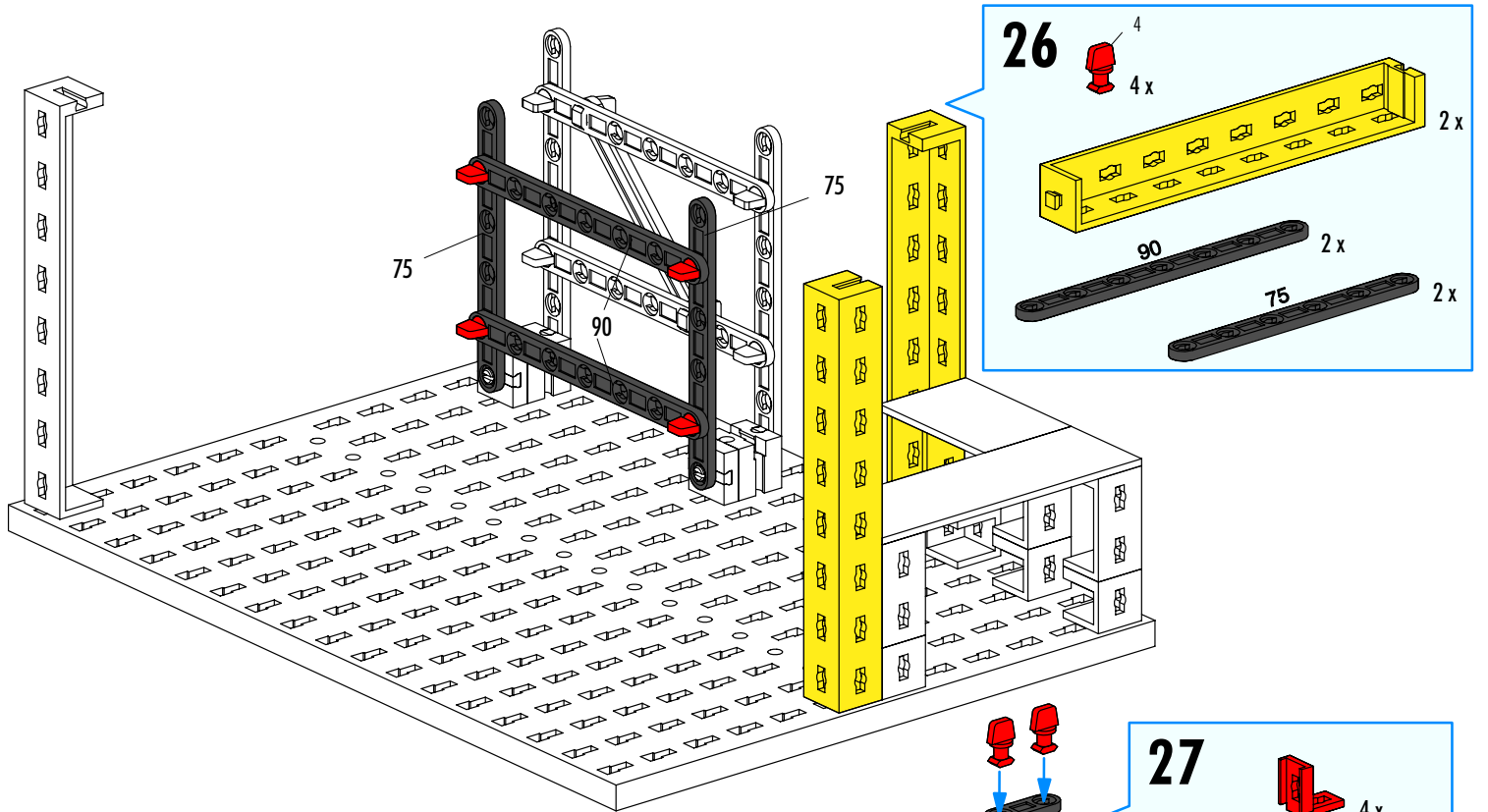

28

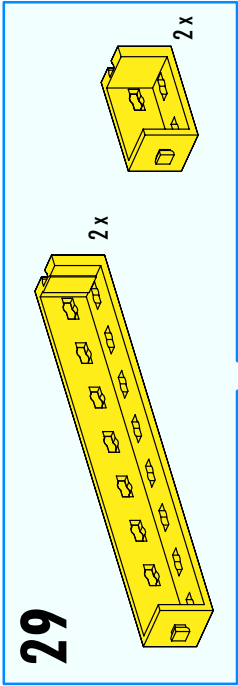
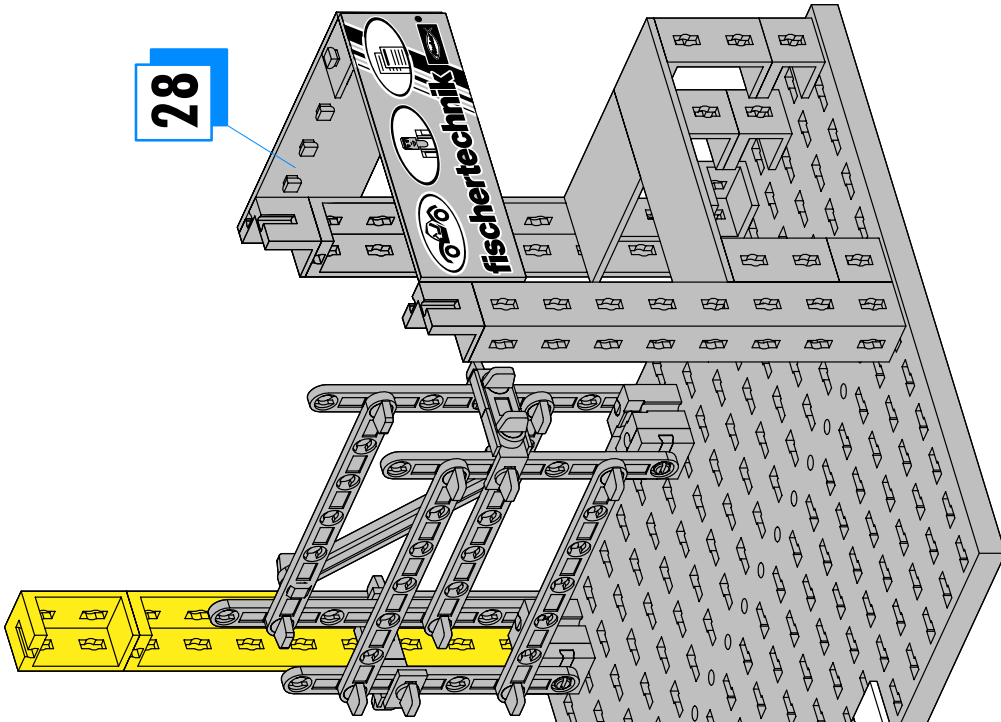

29

23

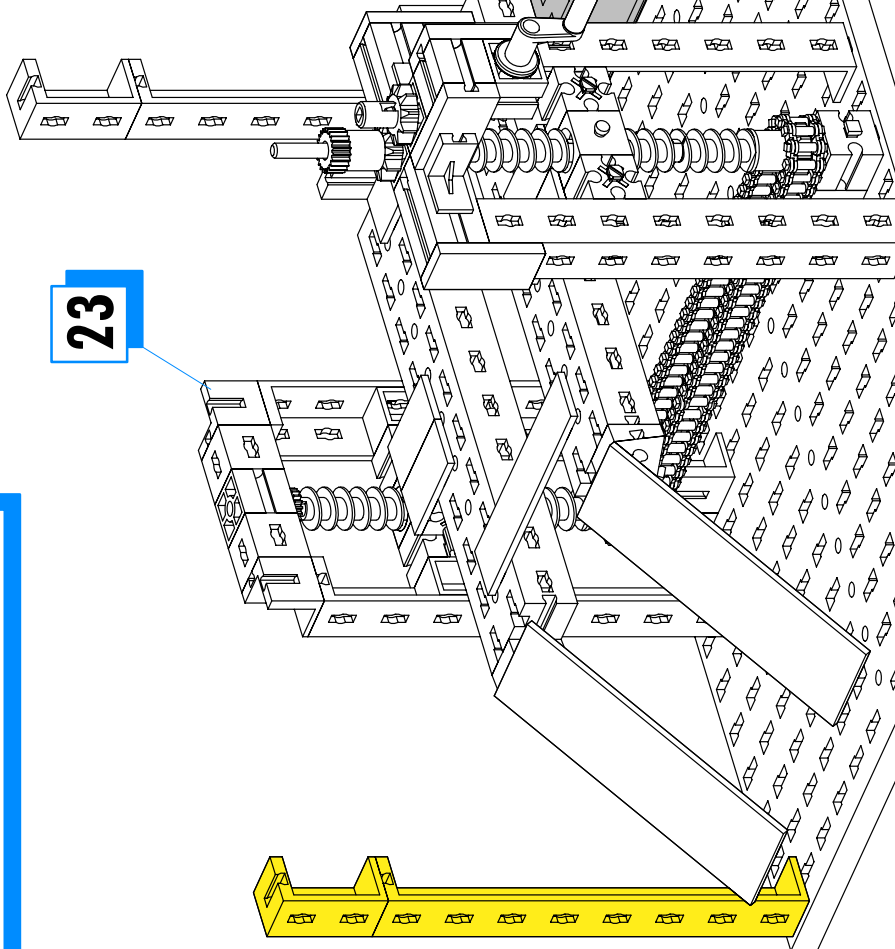

30

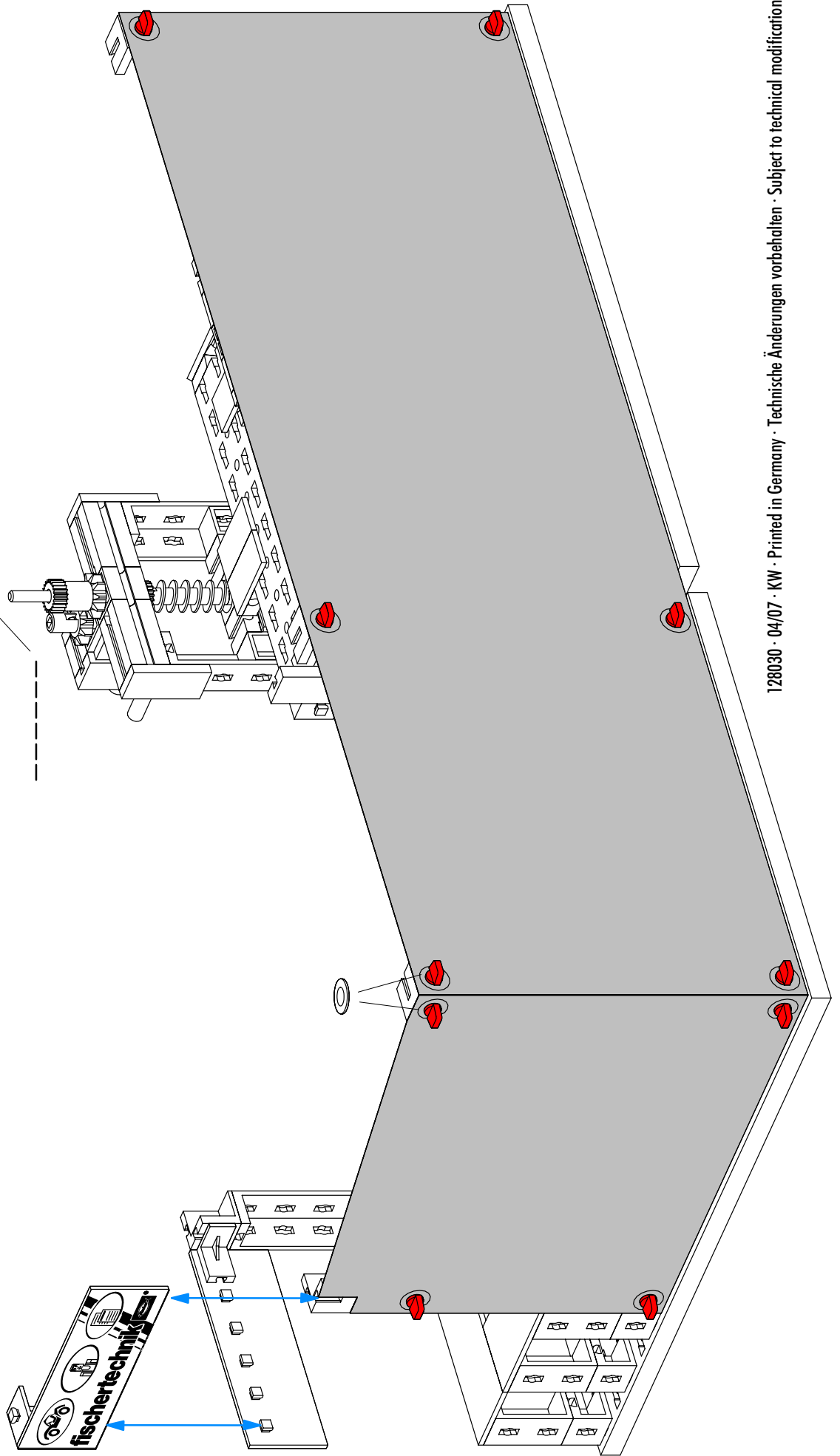
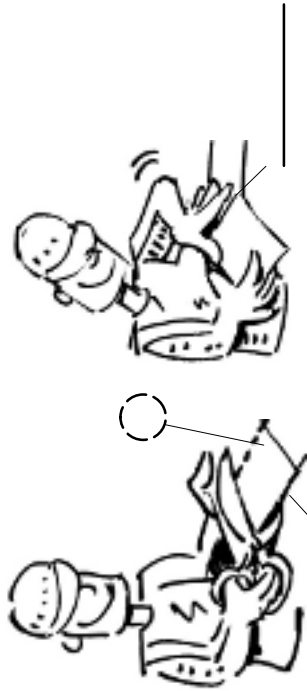
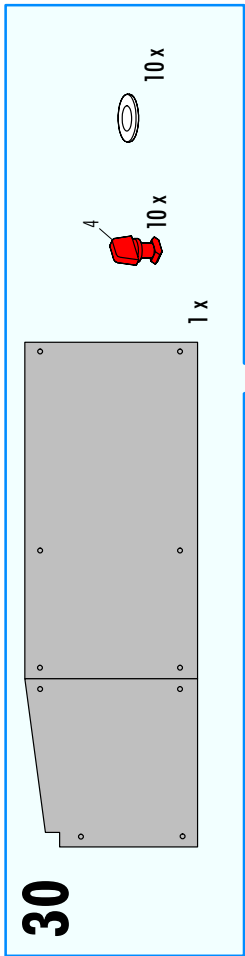



fischertechnik 

fischertechnik GmbH
Weinhalde 14-18
72178 Waldachtal
Germany

Phone +49 74 43/12-43 69
Fax +49 74 43/12-45 91

info@fischertechnik.de
www.fischertechnik.de

128 030 - Printed in Germany
Technische Änderungen vorbehalten
Subject to technical modifications



CAR TUNING CENTER
6 MODELS