

MASTERPLUS

SKY HOPPERS

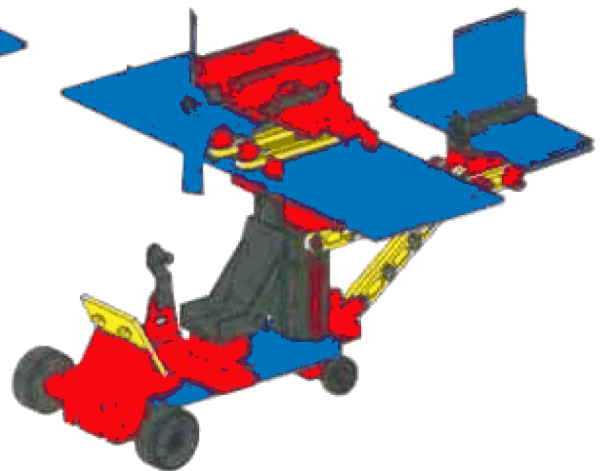

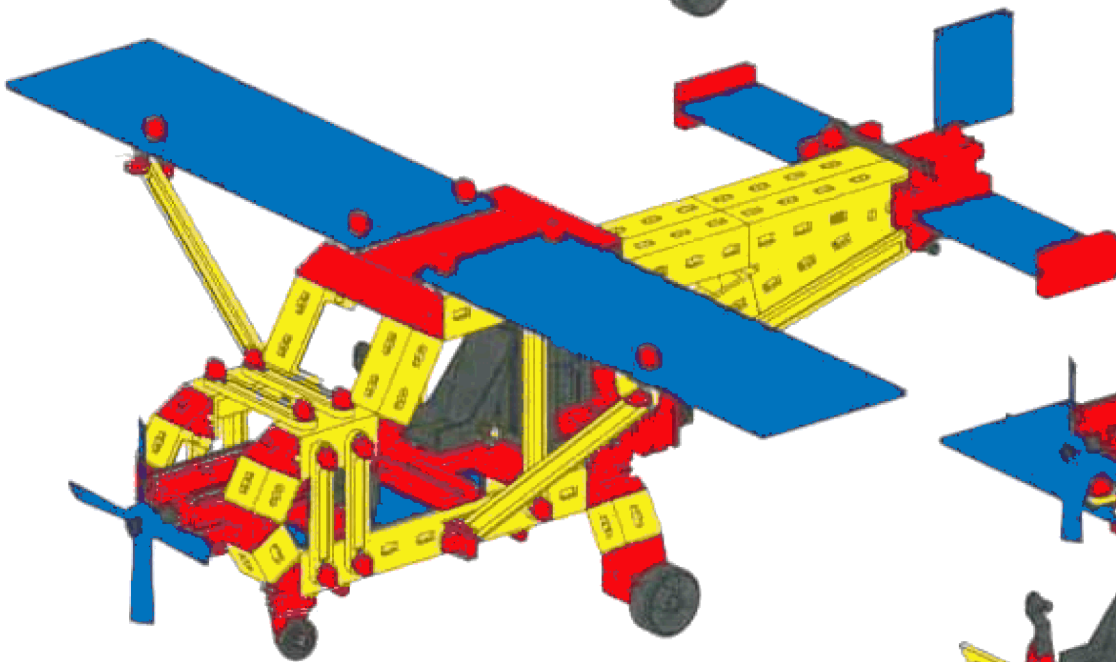

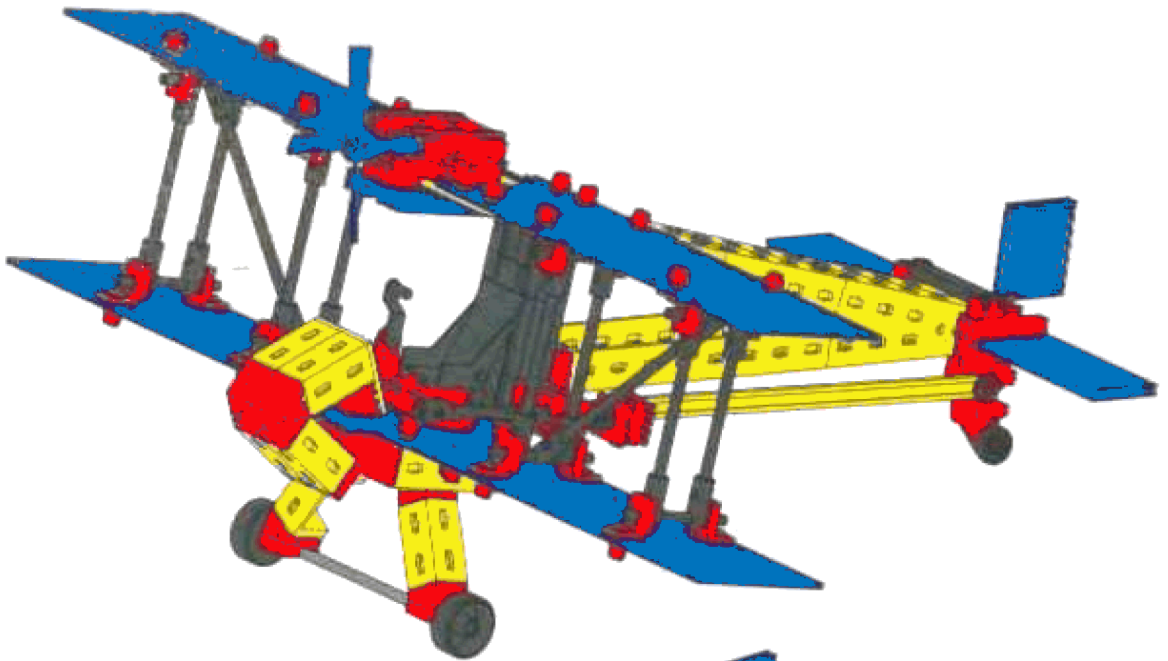
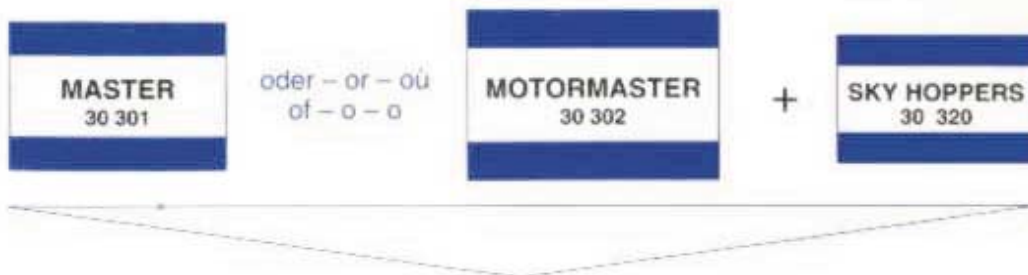







































































Einzelteilübersicht • Spare parts list • Liste des pièces détachées Onderdelenoverzicht • Lista de piezas • Lista dei pezzi	1
Ultraleichtflugzeug • Ultralight aircraft • Avión ultraligero Ultra Light vliegtuig • Aeroplano di lega leggera • ULM	3
Schulflugzeug • Training aircraft • Avion-école Lesvliegtuig • Avión para enseñanza • Velivolo per addestramento	5
Flugzeug mit Tower • Aircraft with tower • Avion avec tour de contrôle Vliegtuig met verkeerstoren • Aeroplano con torre • Aeroplano con tower	8
Wasserflugzeug • Seaplane • Hidroplano Watervliegtuig • Idrovolanto • Hydravion	12
Piper Alpha	15
Doppeldecker • Biplane • Biplano Tweedekker • Biplano • Biplan	18
Motorisierung • Motor unit • Motorisation Motorisring • Motorización • Motorizzazione	22

Einzelteilübersicht
Spare parts list
Liste des pièces détachée

Onderdelenoverzicht
Lista da piezas
Lista dei pezzi

	31010 12x		31984 1x		35063 1x		35980 6x
	31011 2x		31994 1x		35064 1x		36297 2x
	31040 1x		32064 1x		35065 8x		36299 2x
	31060 1x		32071 5x		35066 2x		36324 4x
	31124 2x		32085 1x		35069 1x		36328 4x
	31330 2x		32200 8x		35073 4x		36330 2x
	31597 2x		32879 3x		35076 4x		36335 3x
	31670 16x		32881 5x		35405 1x		36573 2x
	31765 1x		35049 10x		35668 2x		36574 2x
	31848 4x		35052 2x		35799 1x		36586 2x
	31905 1x		35053 6x		35973 1x		37468 4x
	31909 1x		35054 2x		35975 1x		37681 1x
	31982 7x		35059 4x		35977 1x		38241 1x

	38245 2x		36336 1x				
	38249 1x		36337 1x				
	38251 4x		36338 2x				
	38253 4x		36339 4x				
	38266 1x		36340 4x				
	38413 3x		36341 3x				
	38415 9x		36342 2x				
	38423 2x		36521 2x				
	38428 3x						
	38464 2x						
	38531 2x						
	38843 1x						
	36227 20x						

Ultraleichtflugzeug
 Ultralight aircraft
 Avión ultraligero

Ultra Light vliegtuig
 Aeroplano di lega leggera
 ULM

1

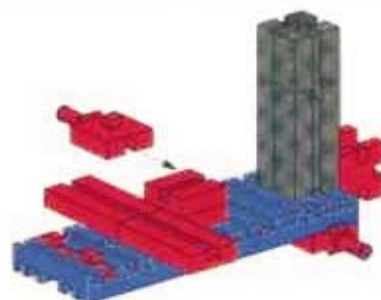
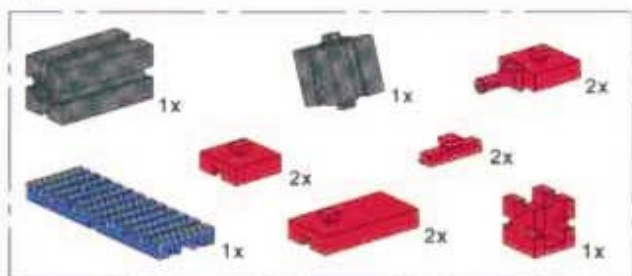

2

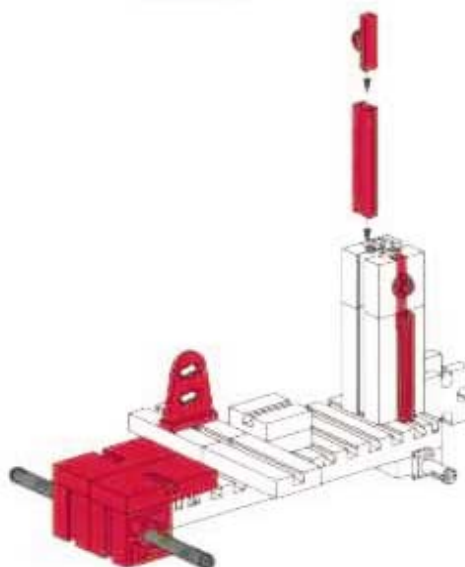
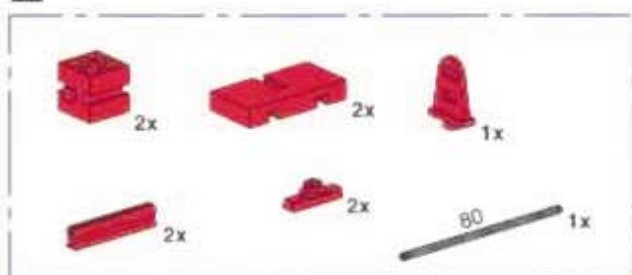

3

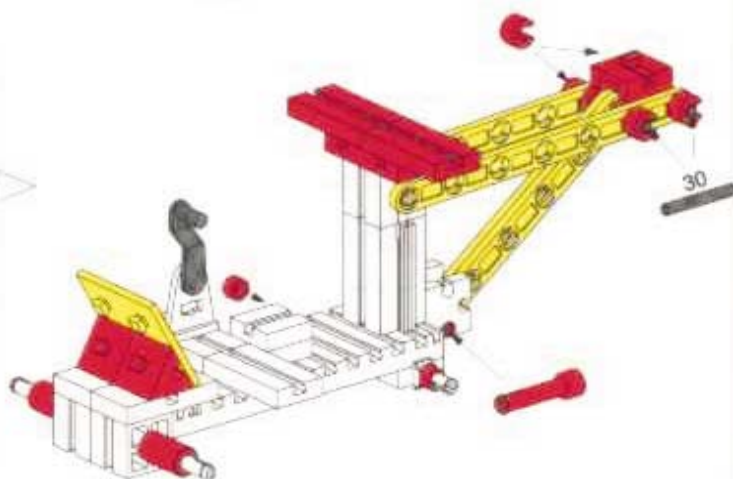
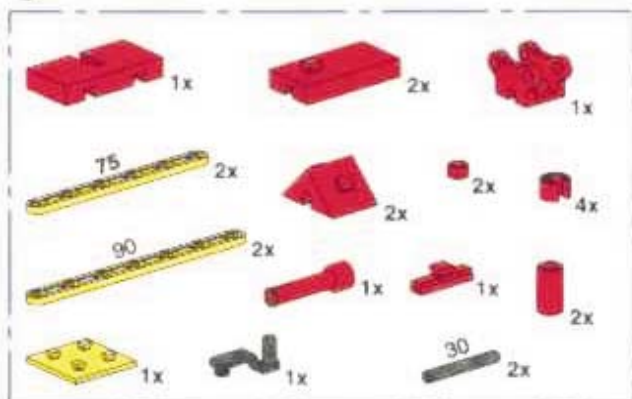

4

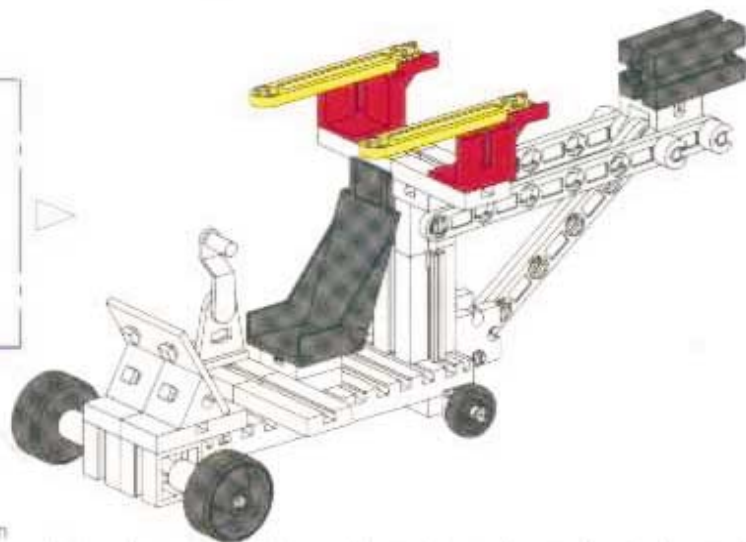
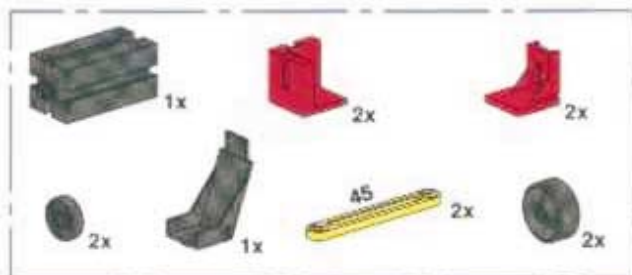

30mm

80mm

5

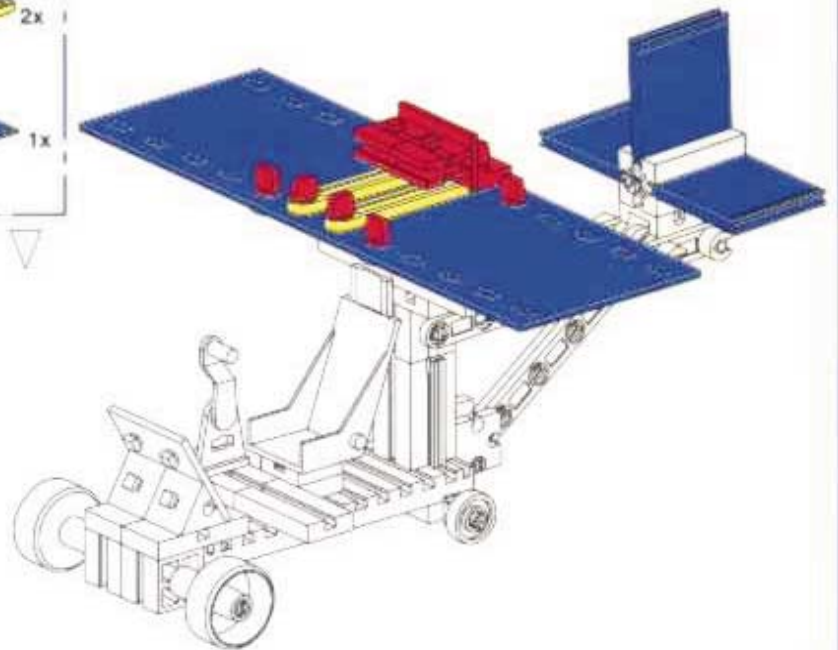
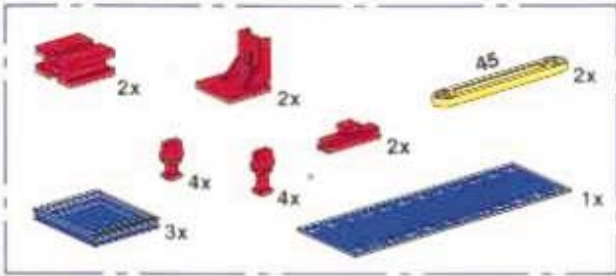

6

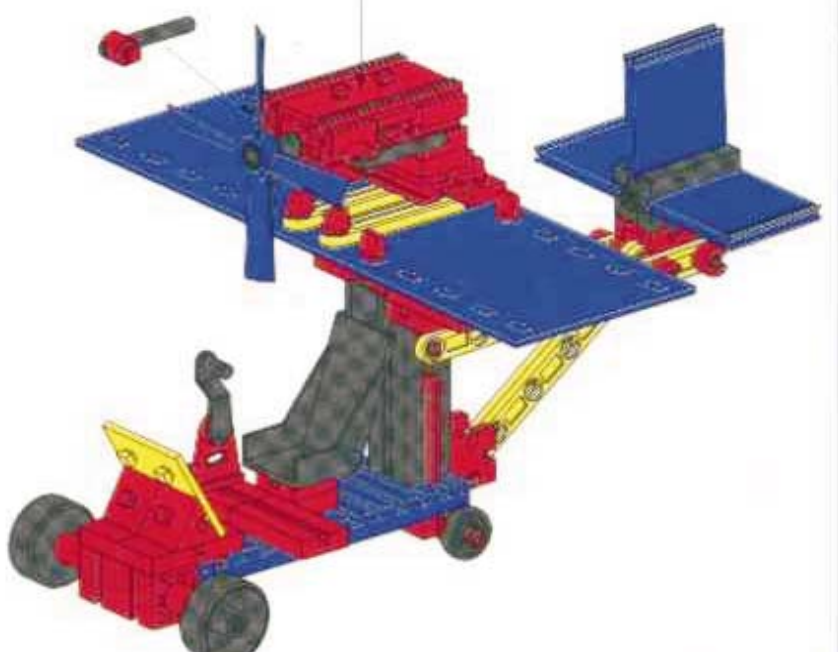
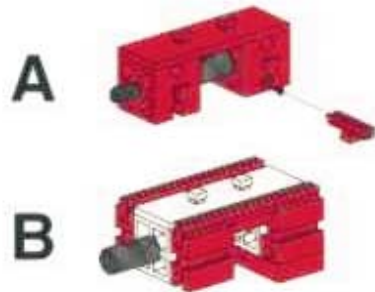
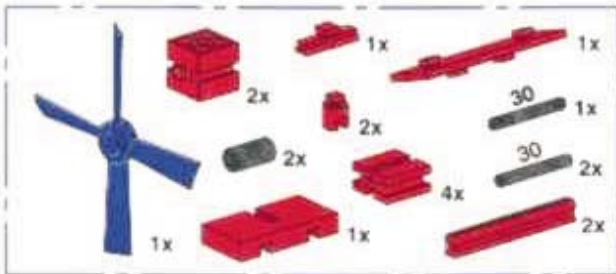

Seite 22
 Page 22
 Page 22
 Bladzijde 22
 Pagina 22
 Pagina 22

30mm

Schulflugzeug
Trainig aircraft
Avion-école

Lesvliegtuig
Avión para enseñanza
Velivolo per addestramento

1

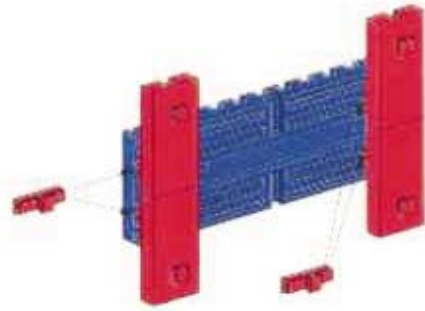

2

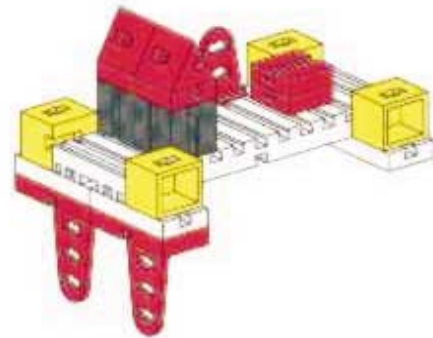
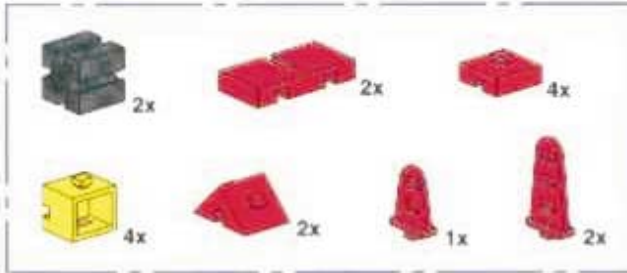

3

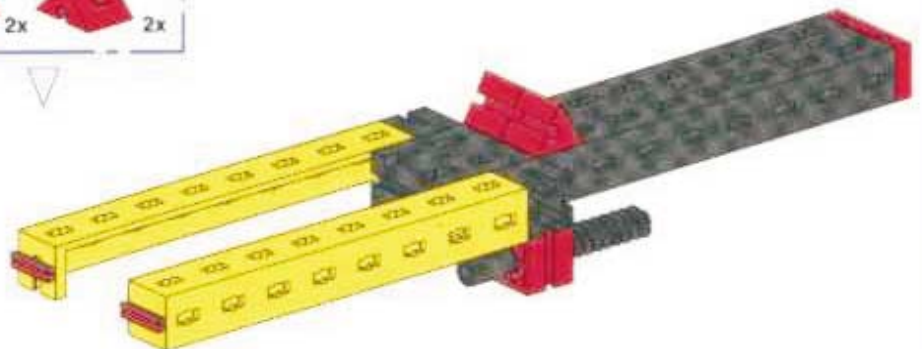
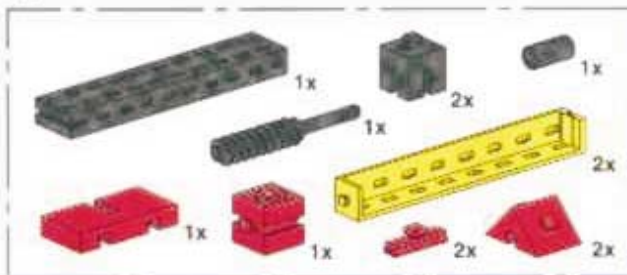

4

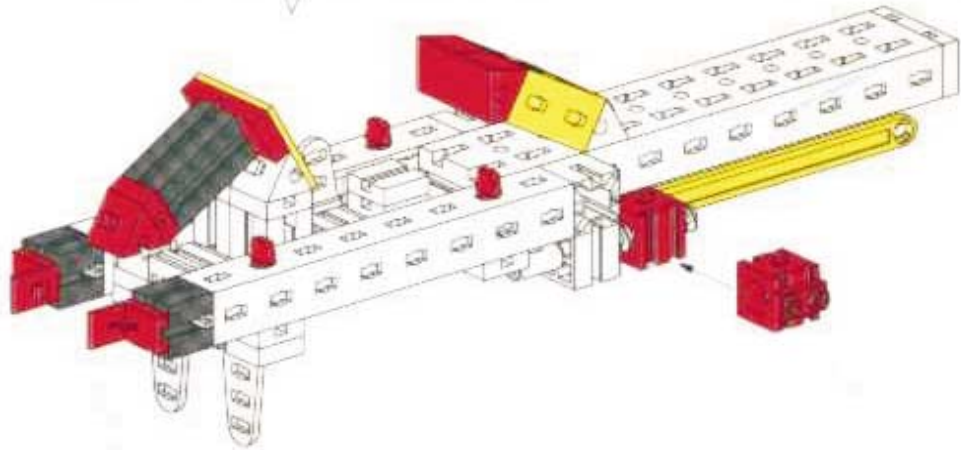
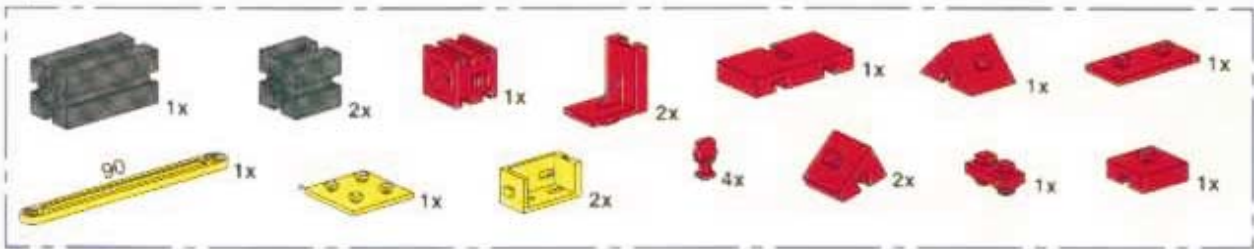

5

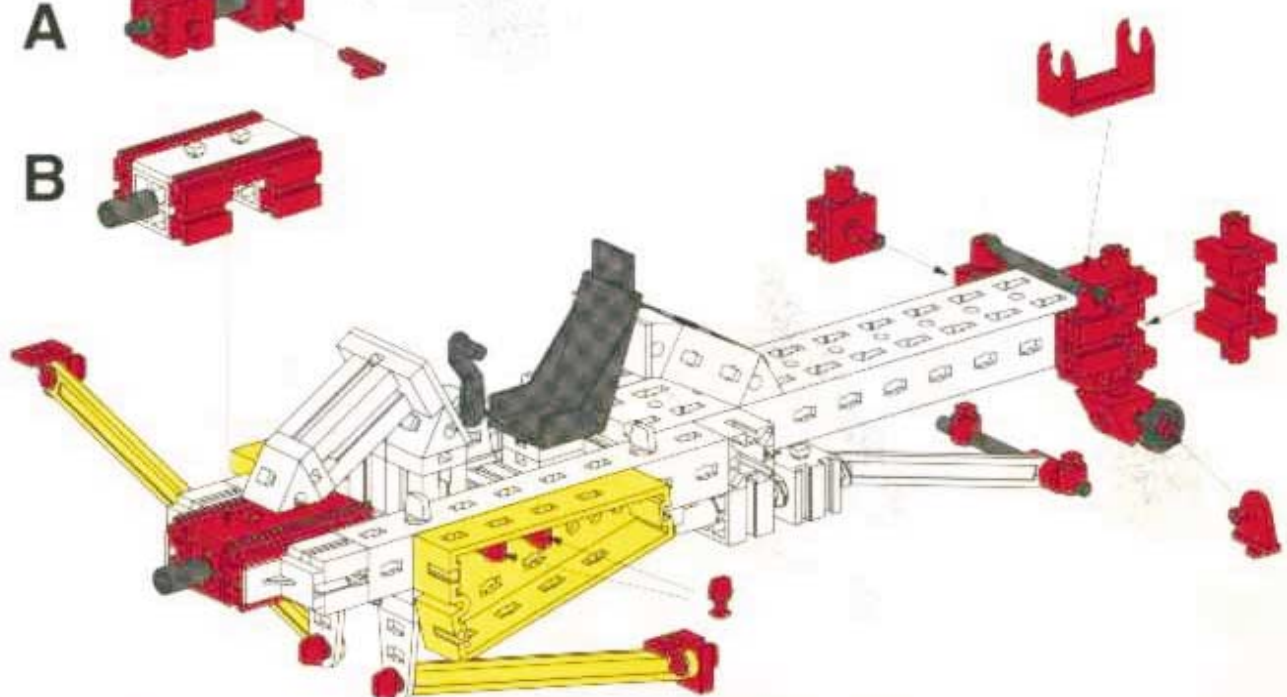
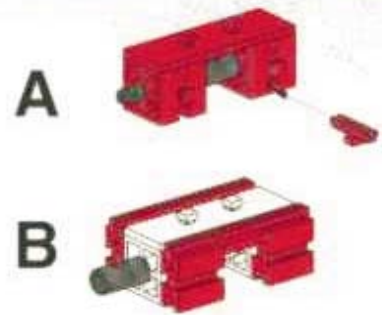
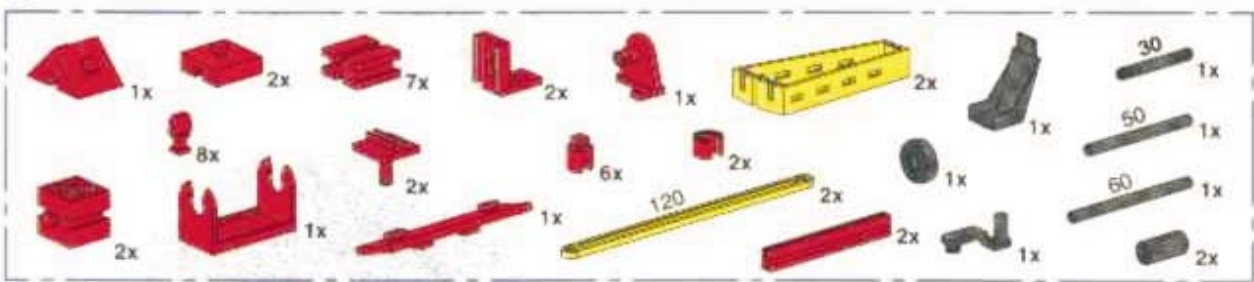

30mm 50mm 60mm

6

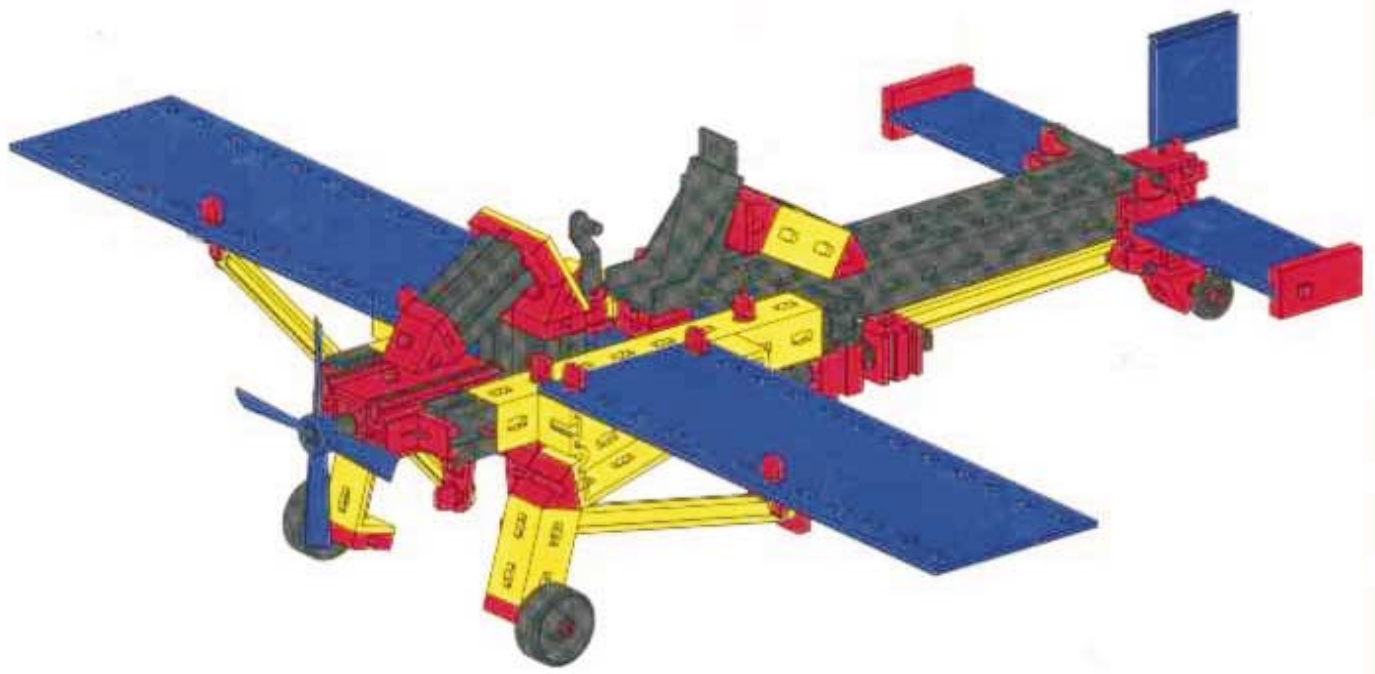
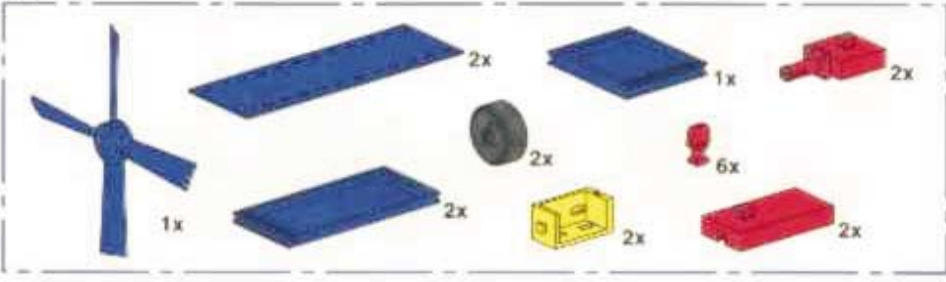

Seite 22
Page 22
Page 22
Bladzijde 22
Página 22
Pagina 22

Flugzeug mit Tower
 Aircraft with tower
 Avion avec tor de contrôle

Vliegtuig met verkeerstoren
 Aeroplano con torre
 Aeroplano con tower

1

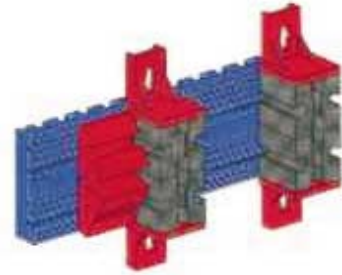
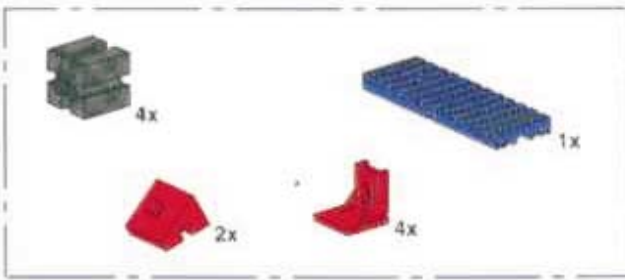

2

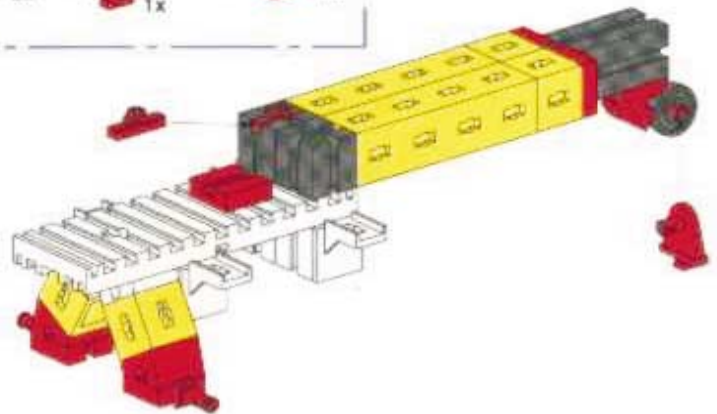
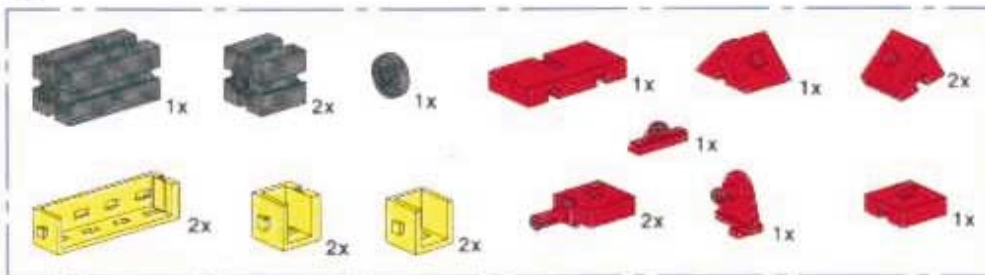

3

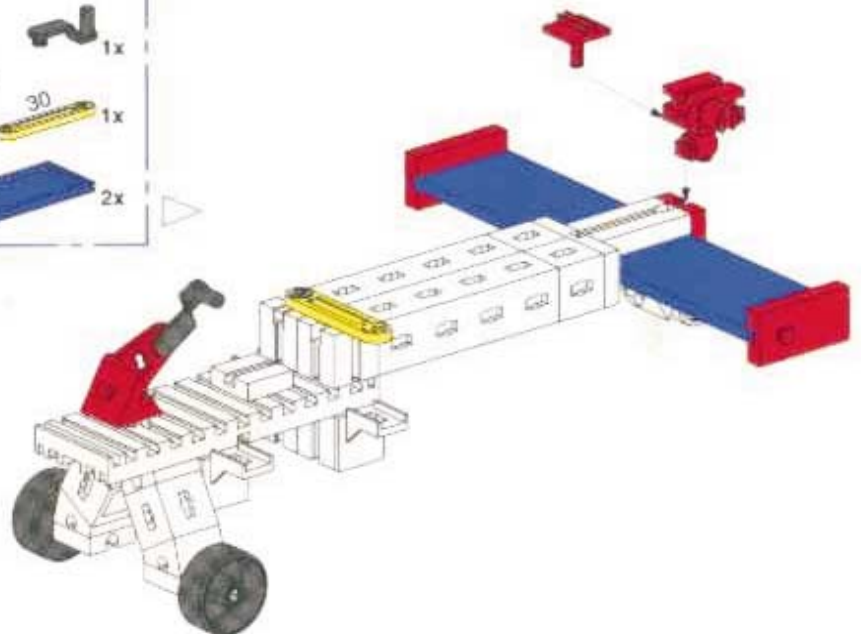
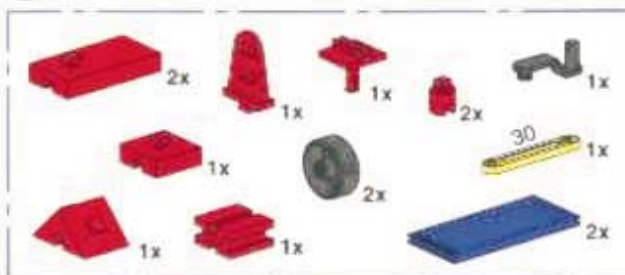

4

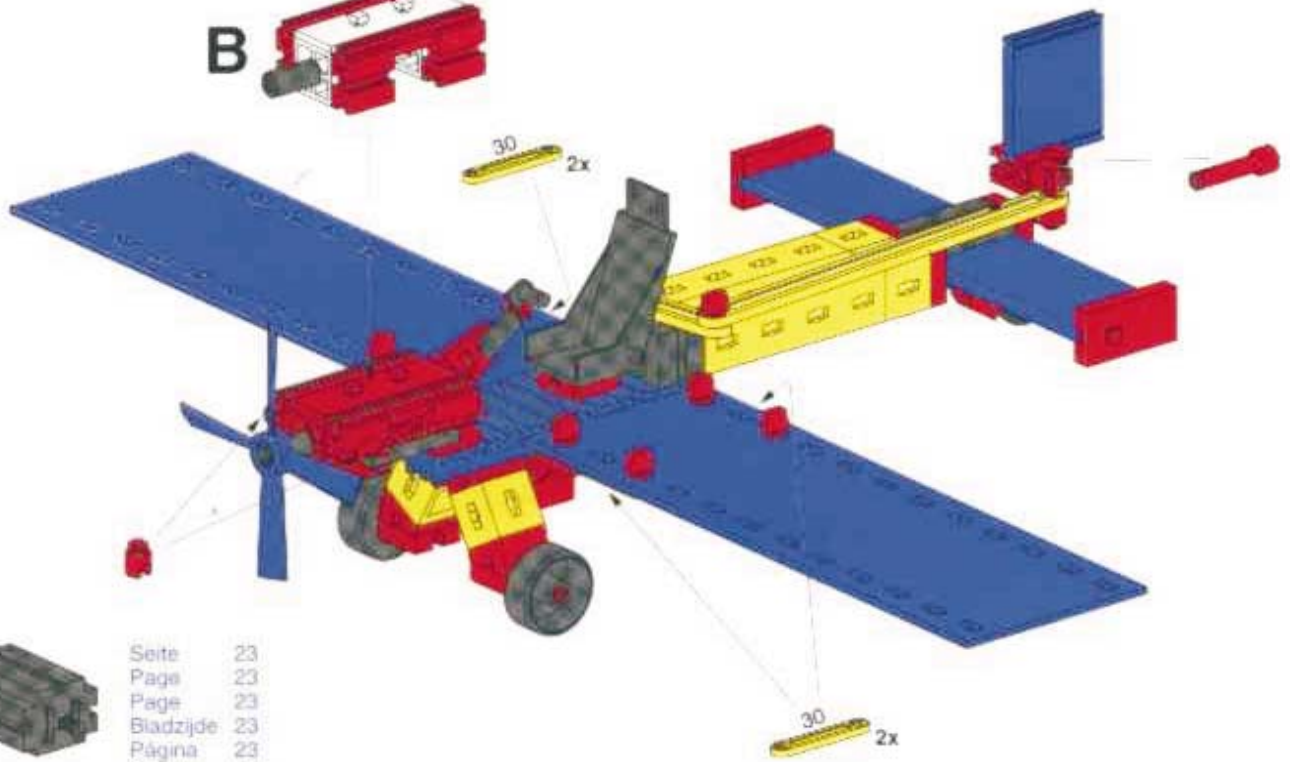
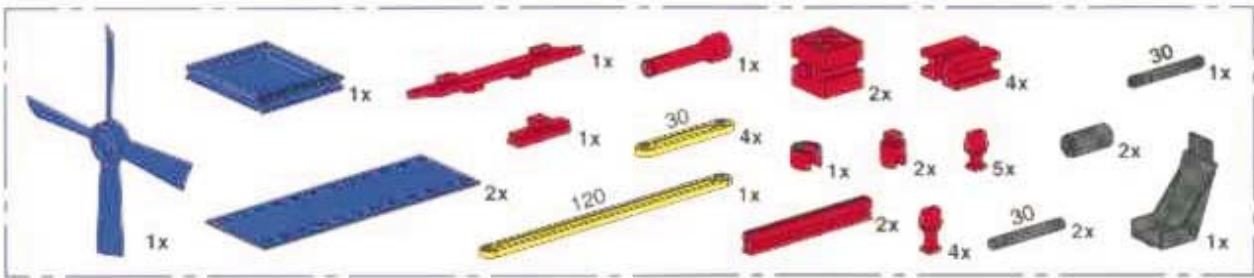

Seite 23
Page 23
Page 23
Bladzijde 23
Página 23
Pagina 23

5

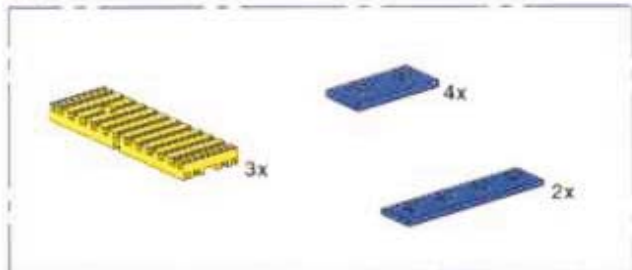

30mm

6

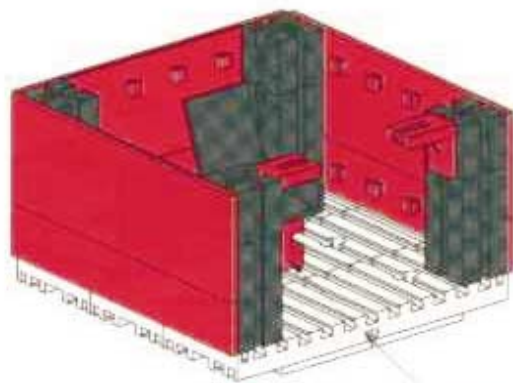
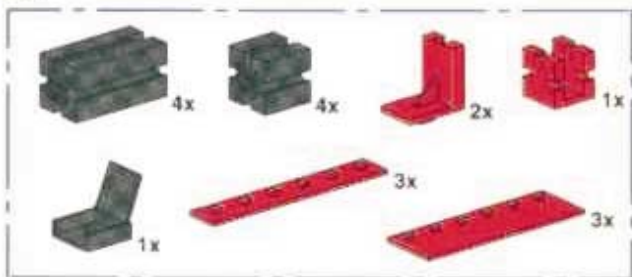

7

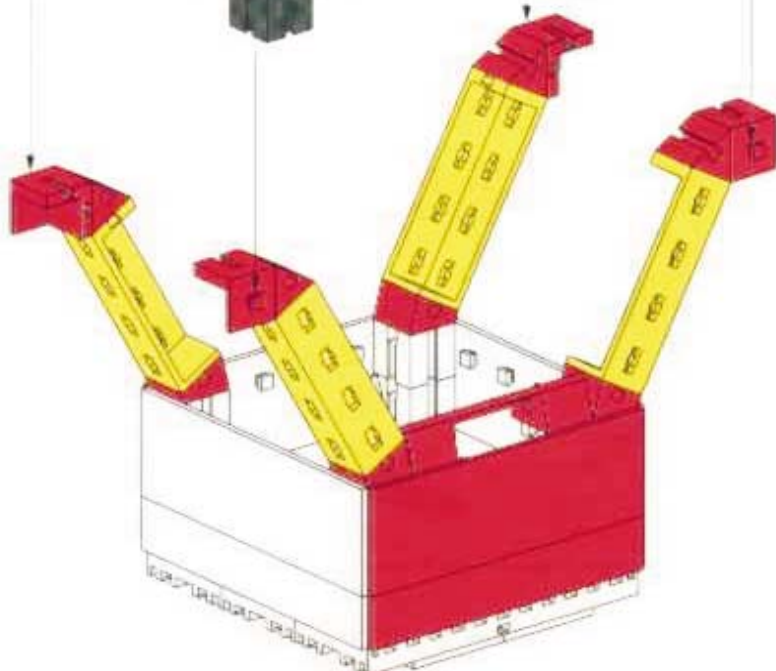
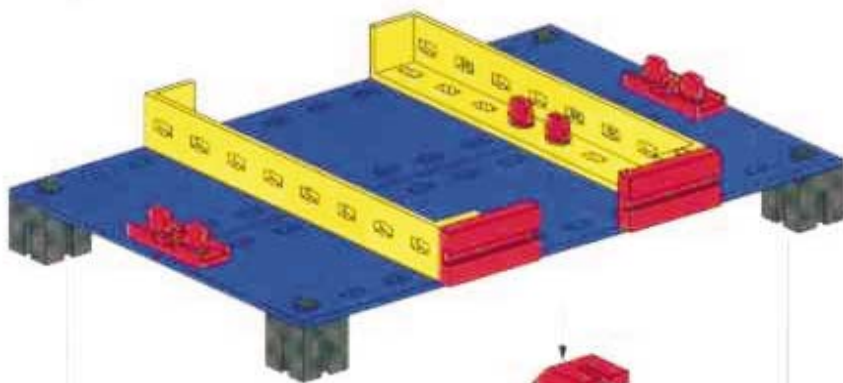
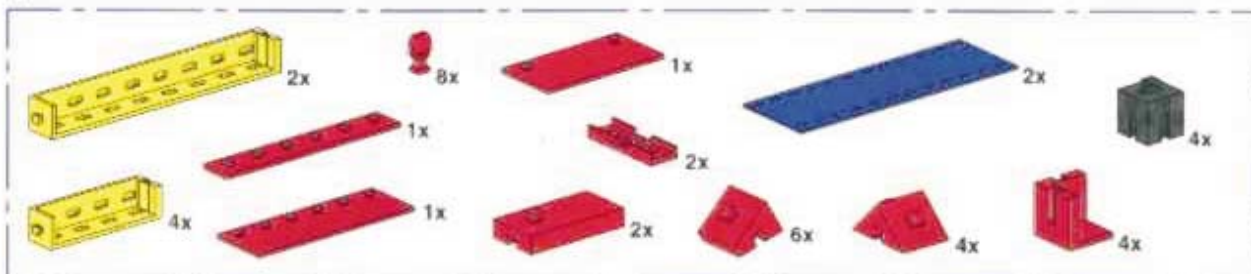

Wasserflugzeug
Seaplane
Hidroplano

Watervliegtuig
Idrovolanto
Hydravion

1

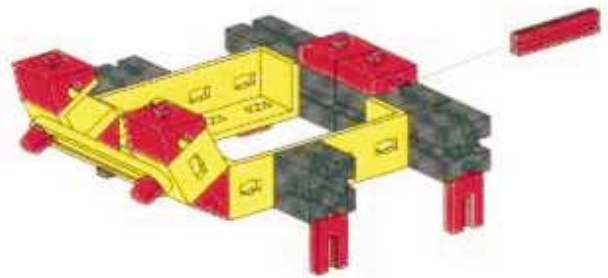
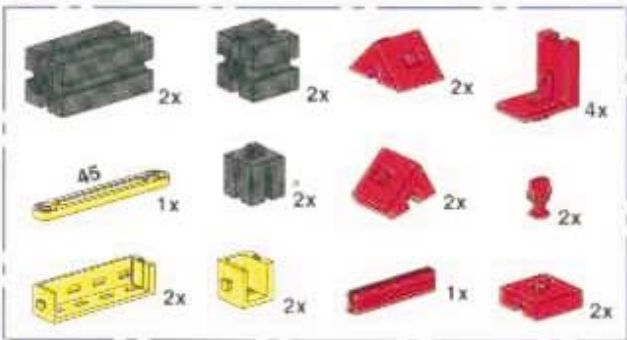

2

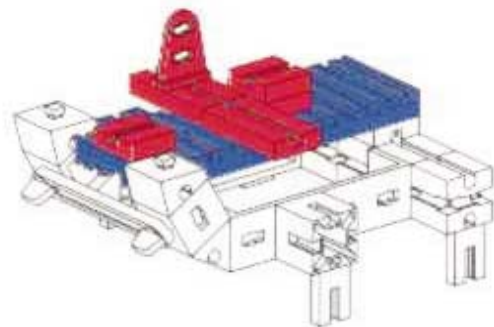
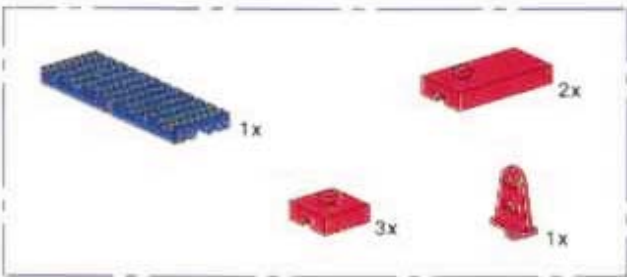

3

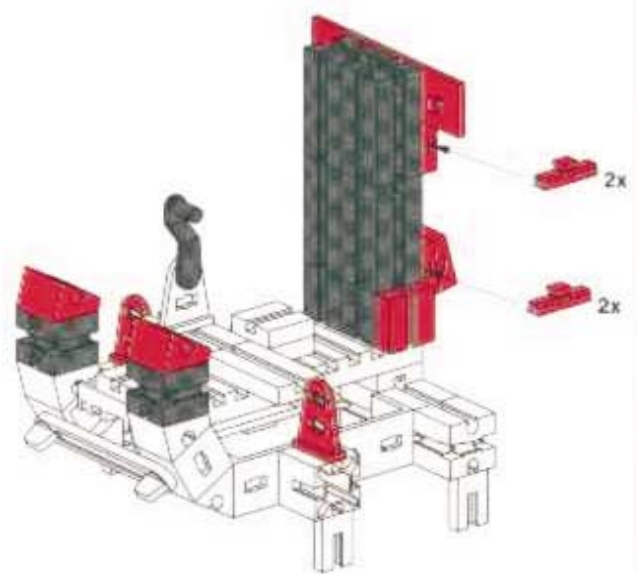
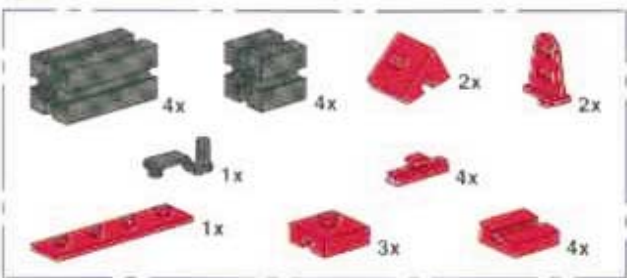

4

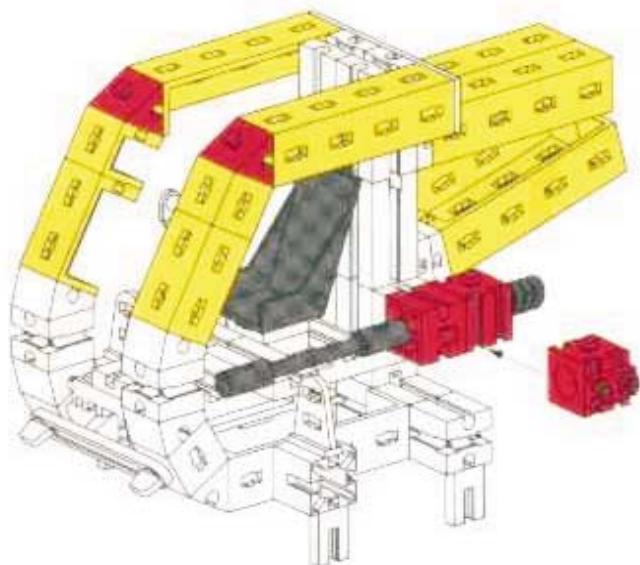
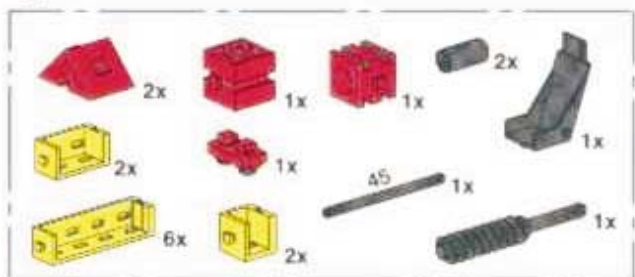

5

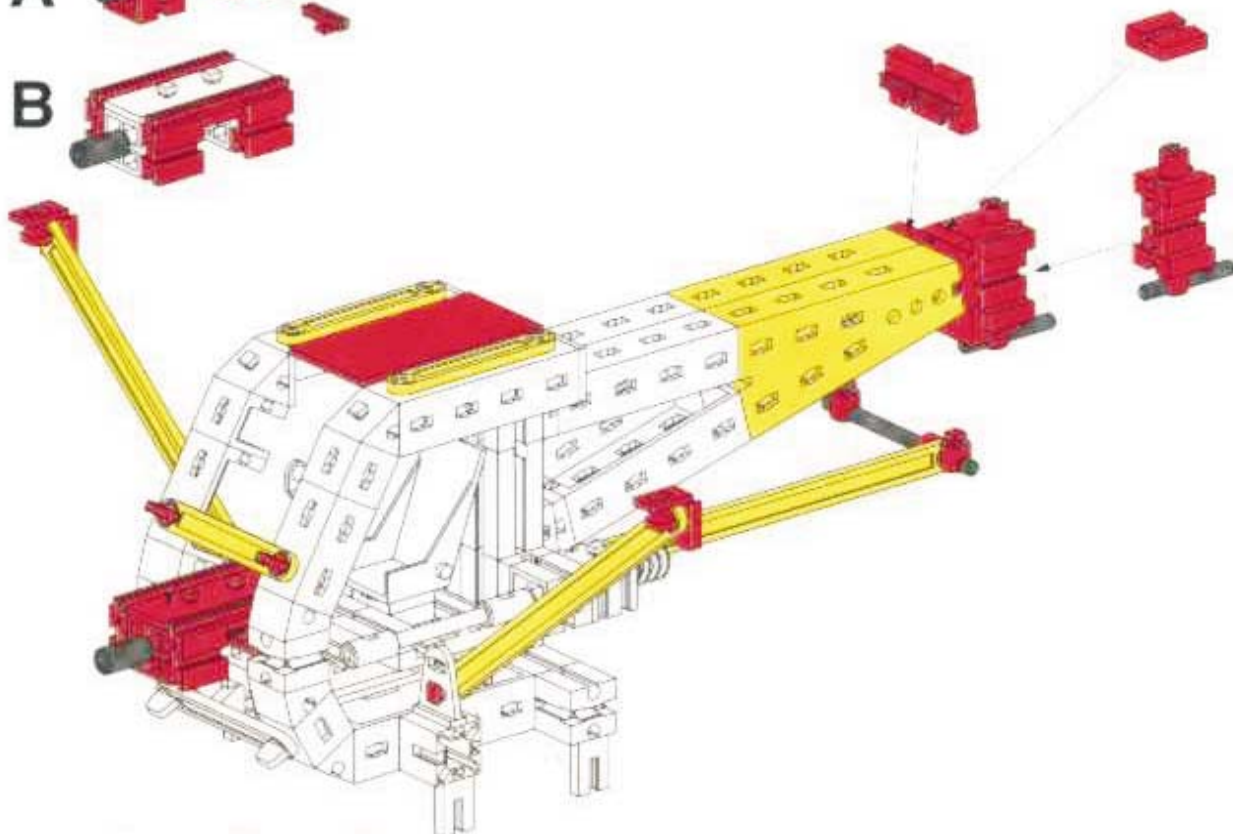
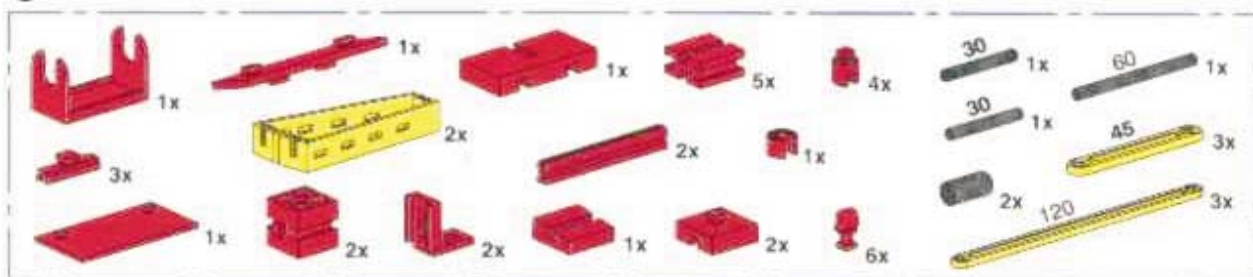

30mm 45mm 60mm

6

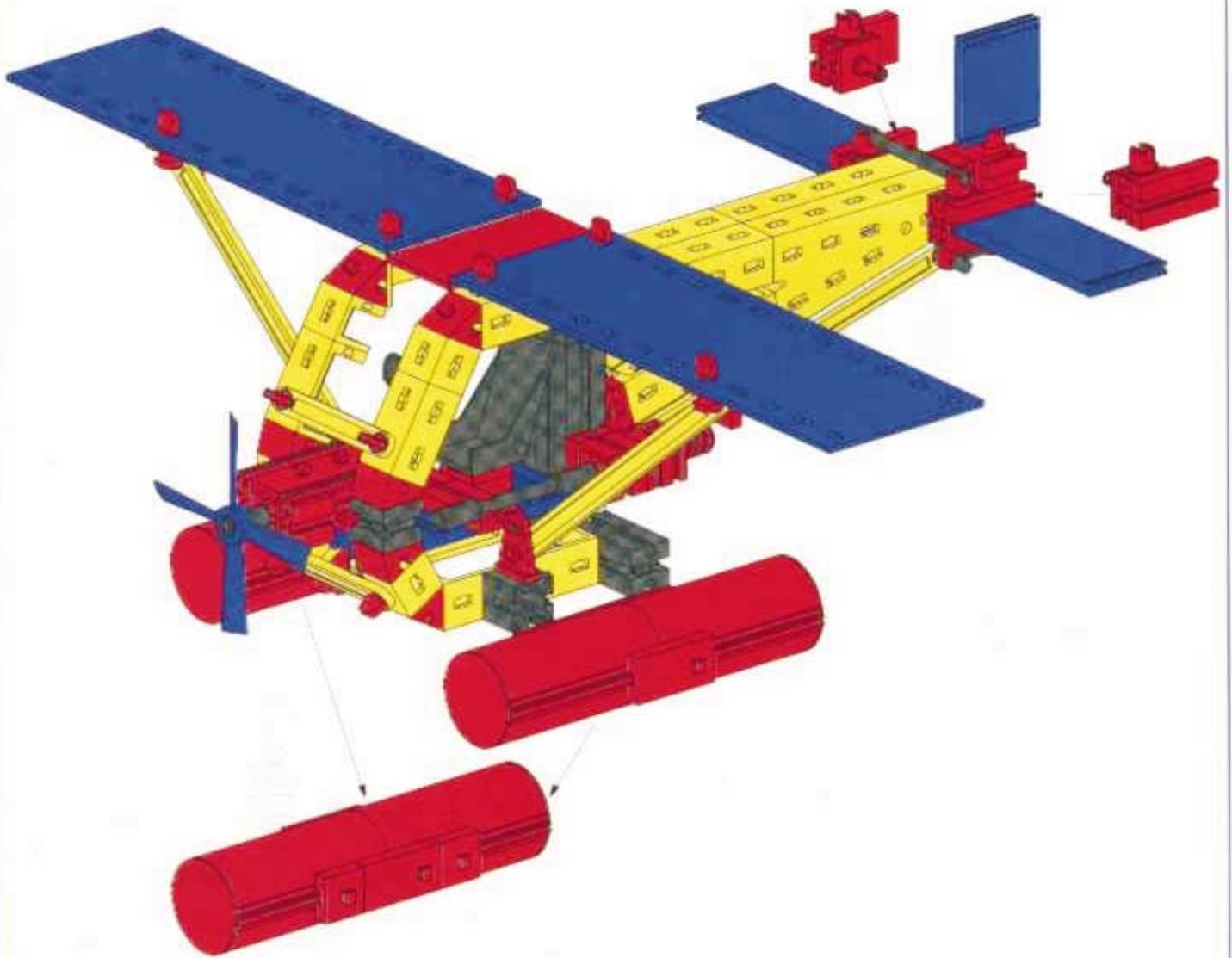
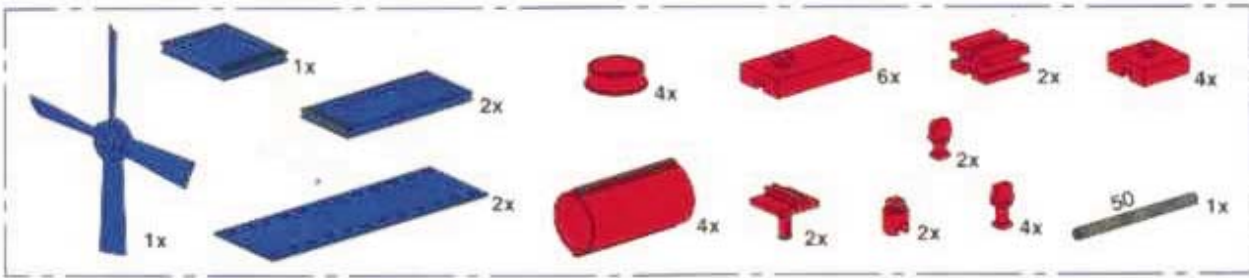

Seite 24
 Page 24
 Page 24
 Bladzijde 24
 Página 24
 Pagina 24

50mm

Piper Alpha

1

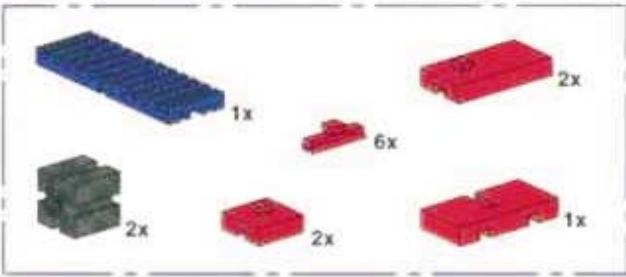

2

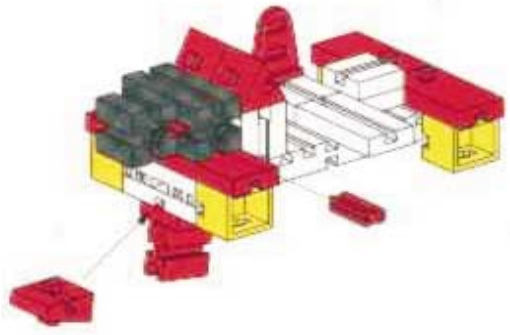
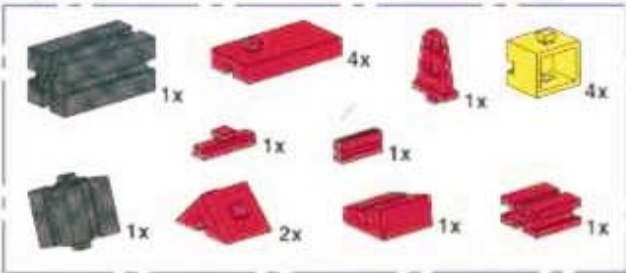

3

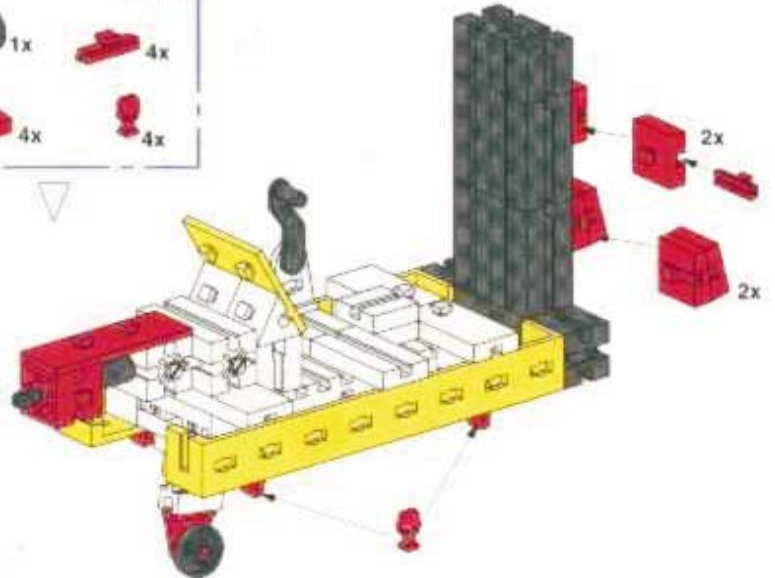

30mm

4

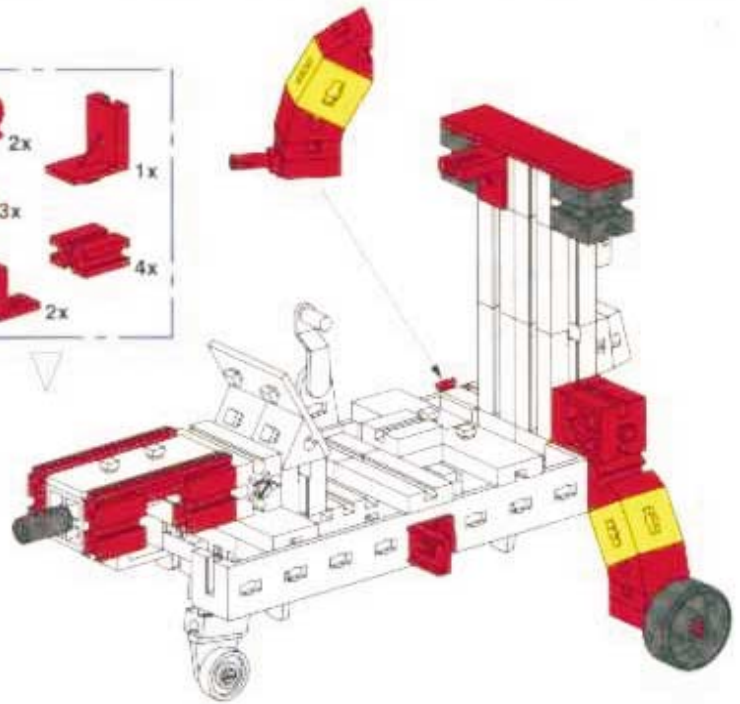
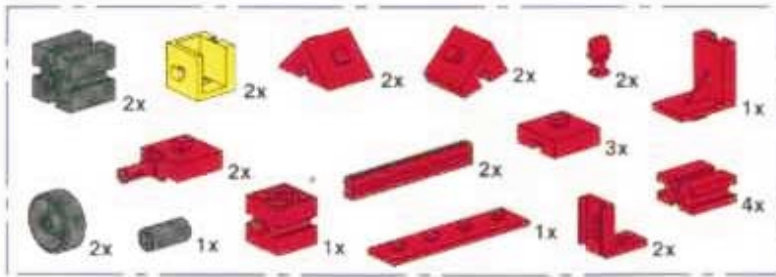

5

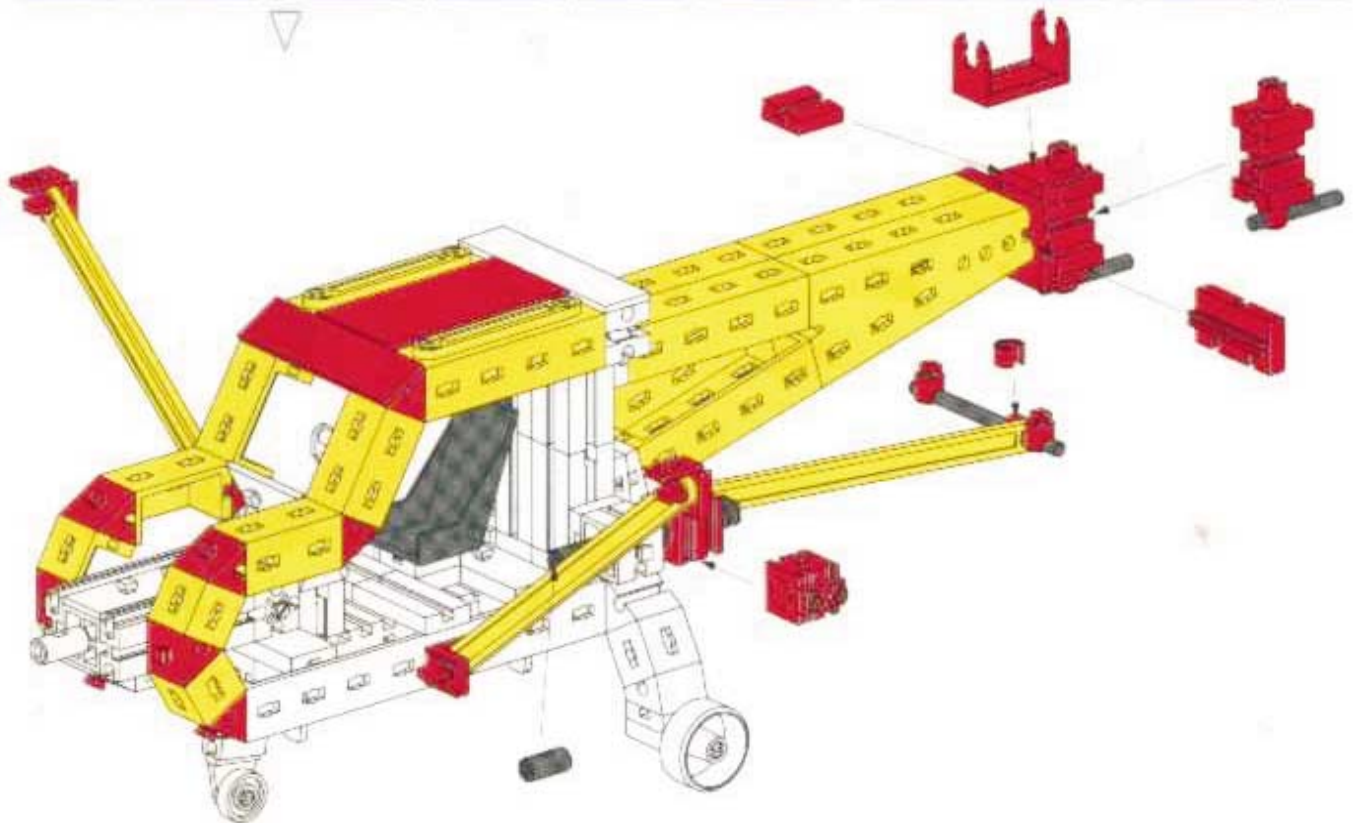
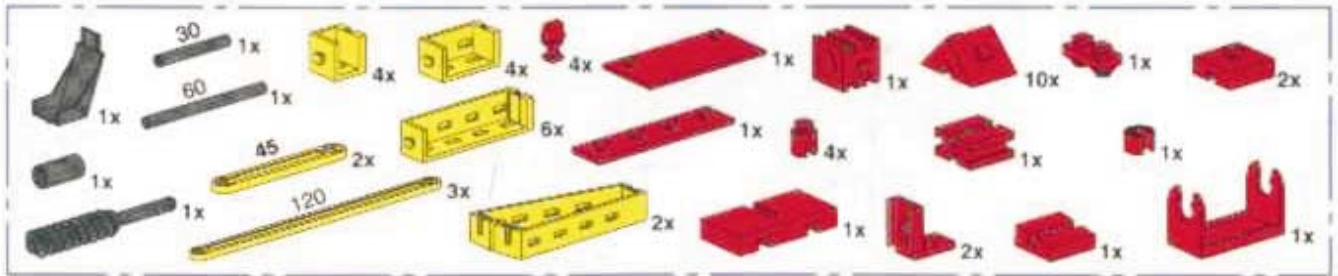

30mm

60mm

6

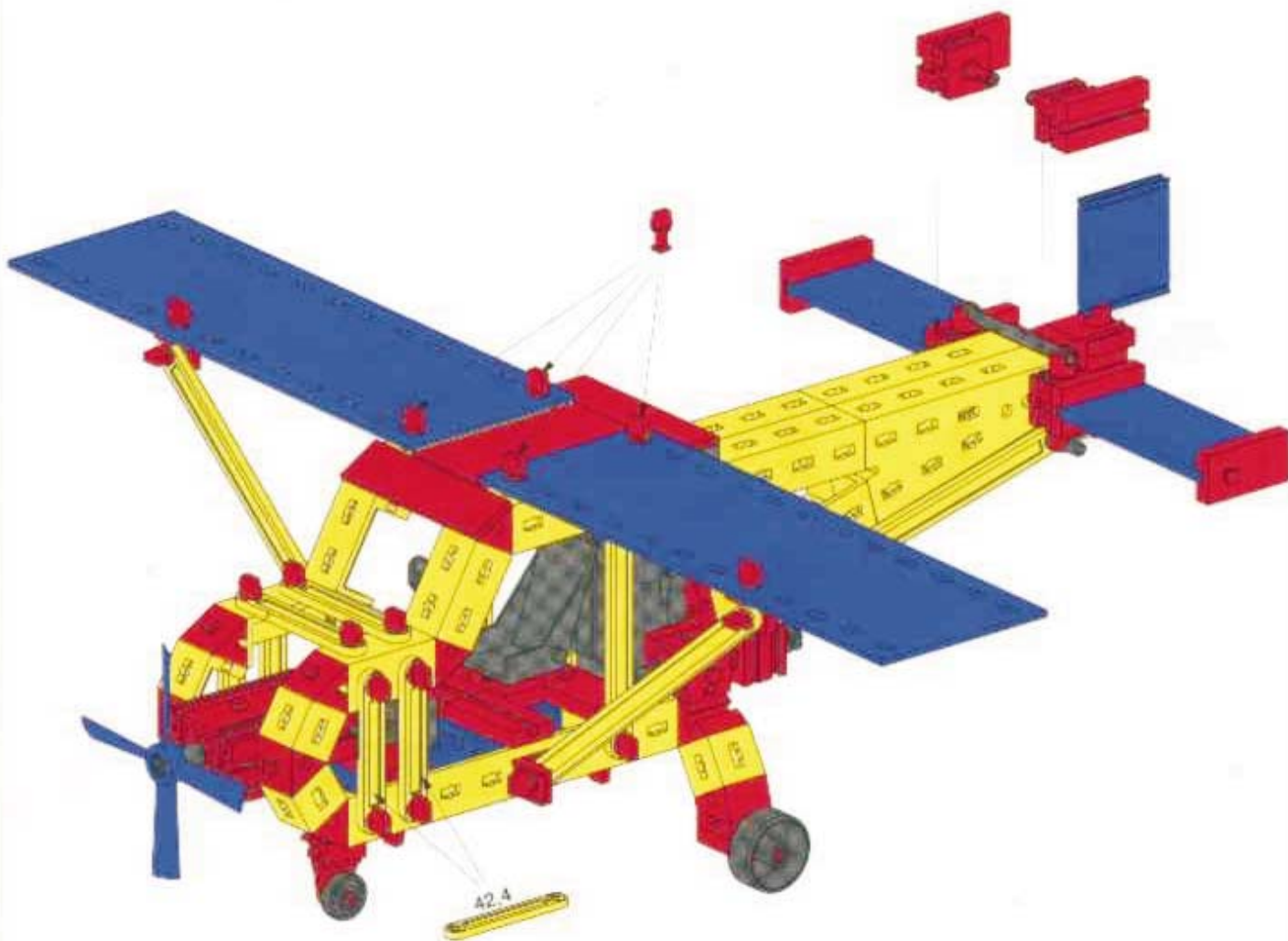
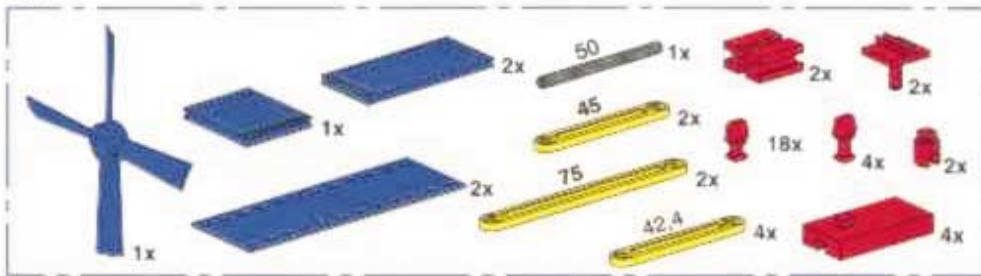

Seite 25
 Page 25
 Page 25
 Bladzijde 25
 Pagina 25
 Pagina 25

50mm

Doppeldecker
Biplane
Biplano

Tweedekker
Biplano
Biplan

1

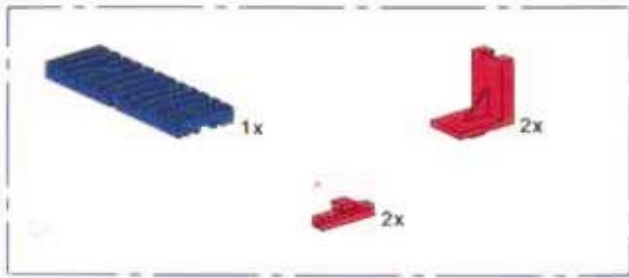

2

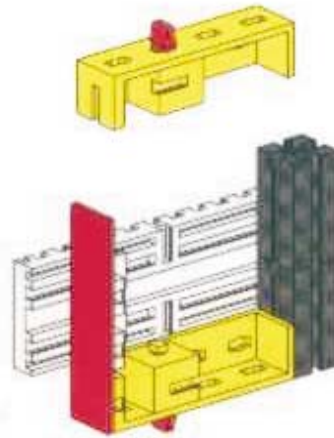
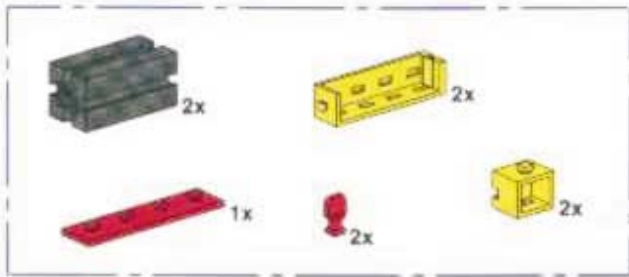

3

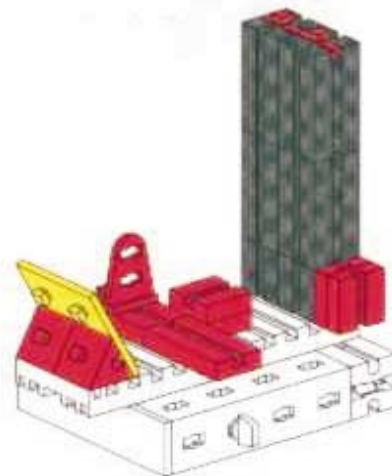
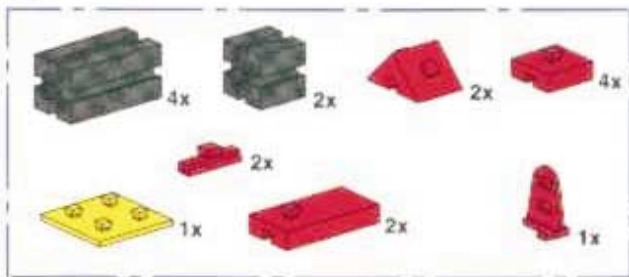

4

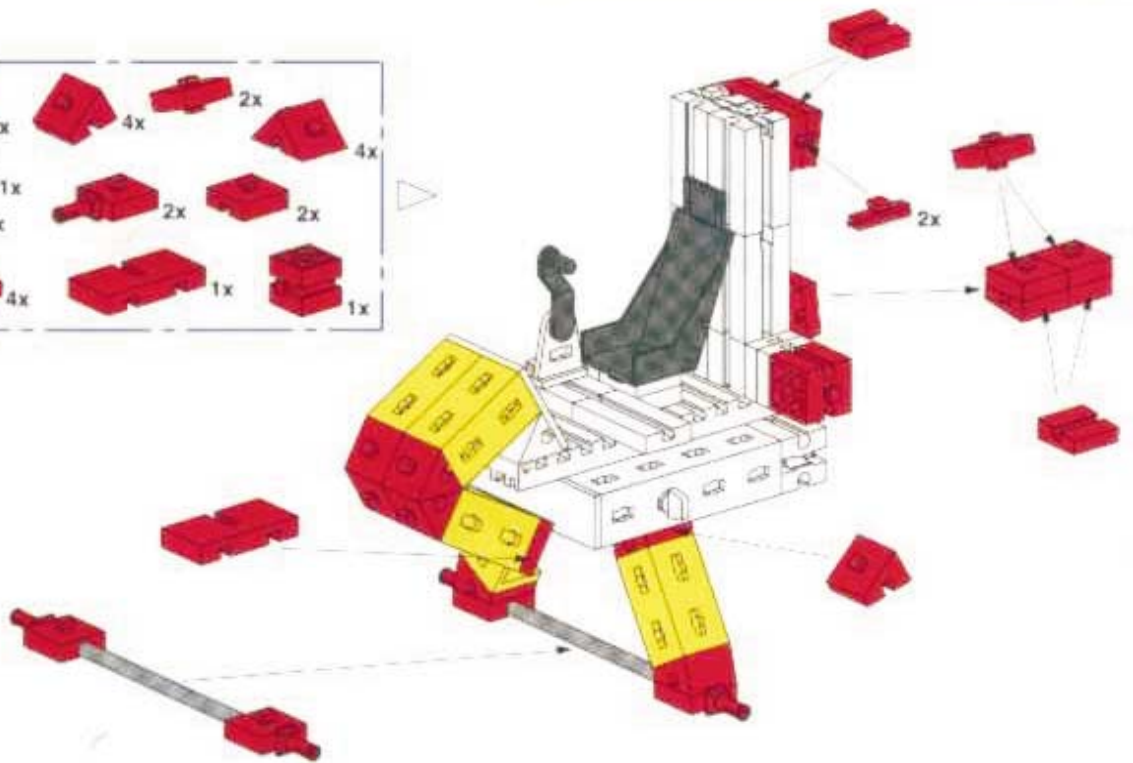
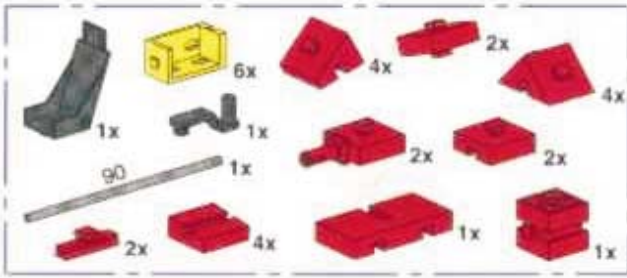

5

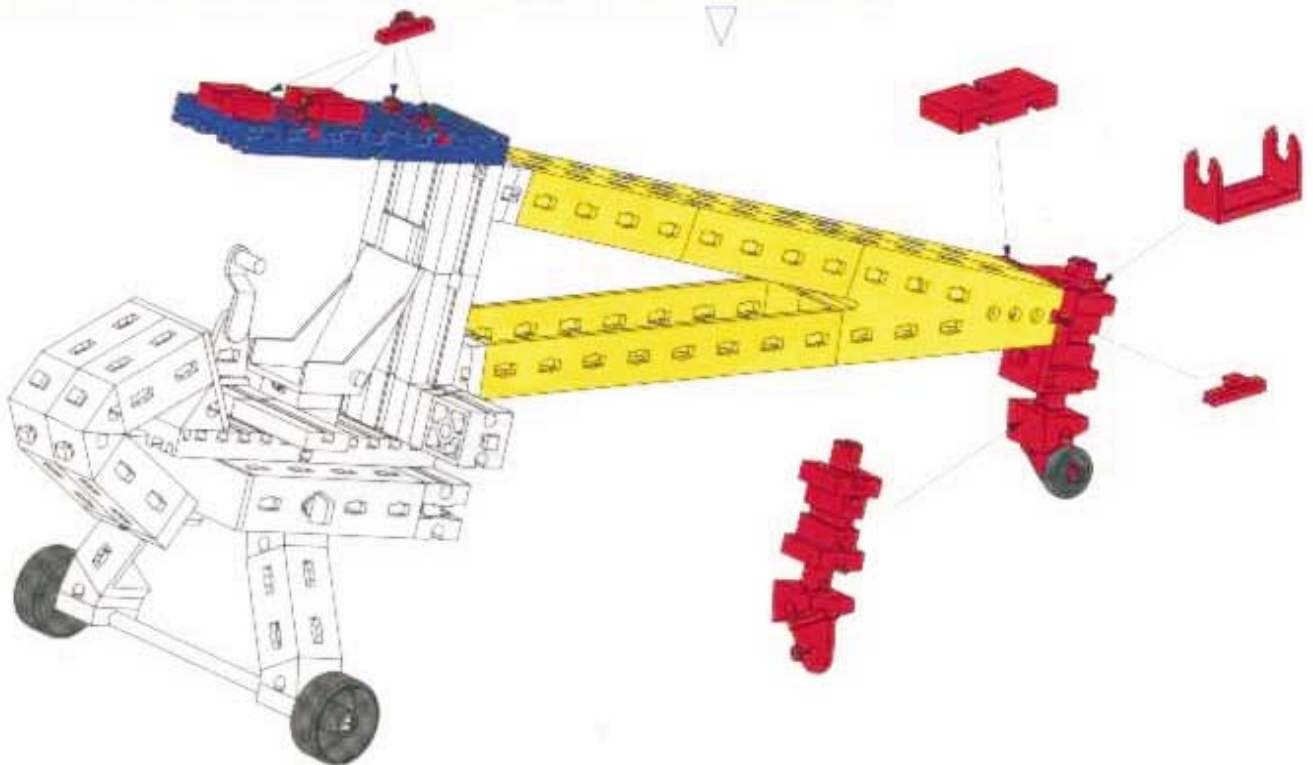
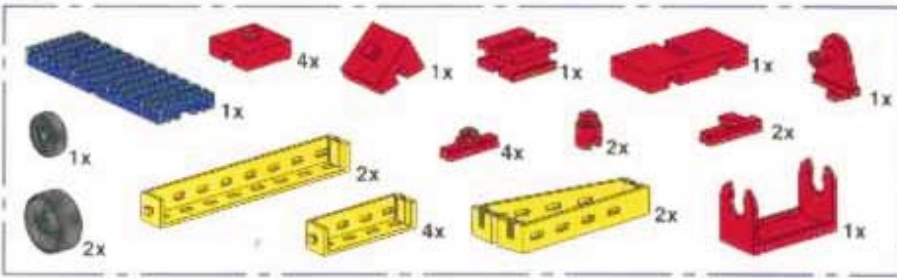

90mm

6

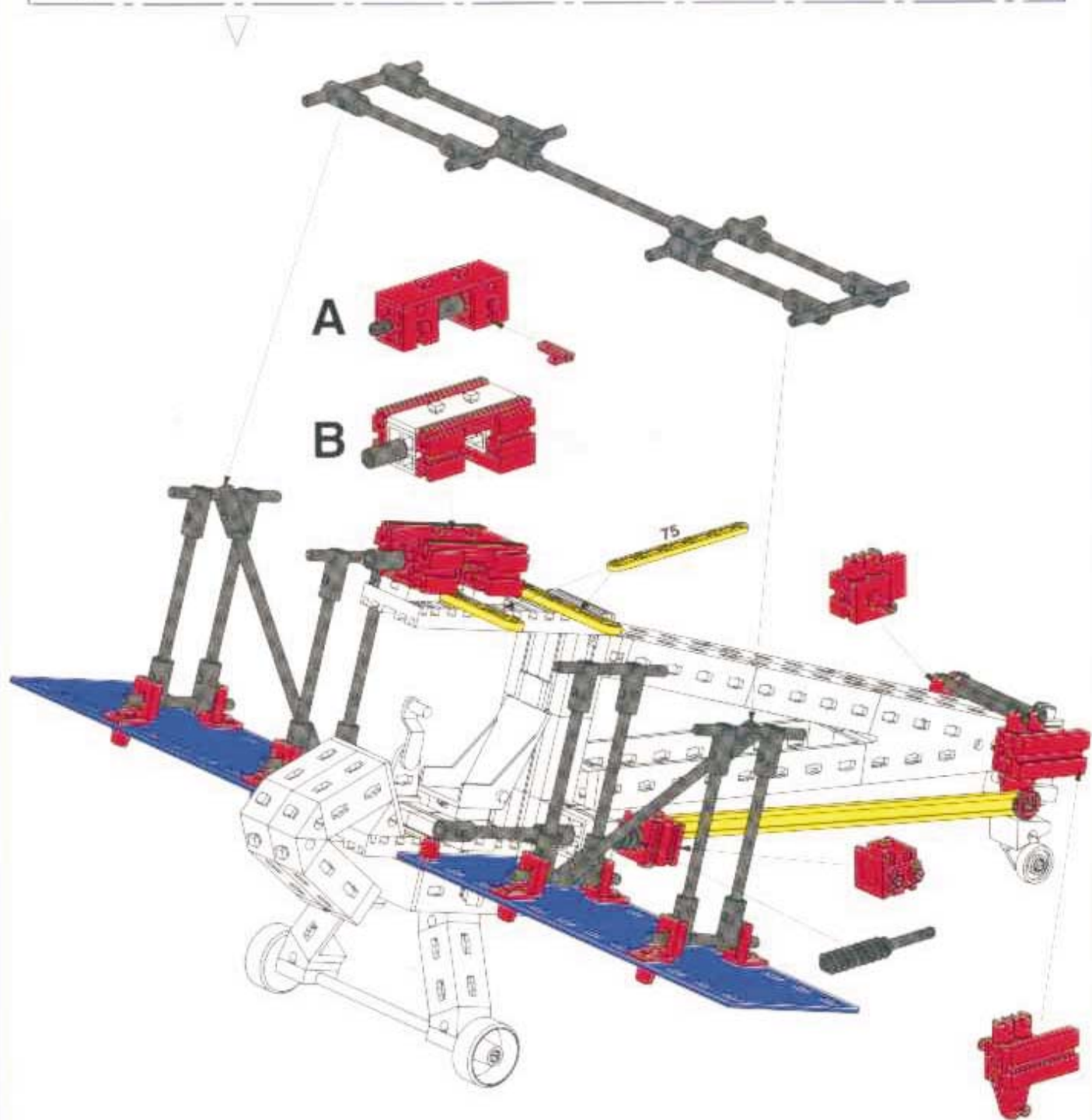
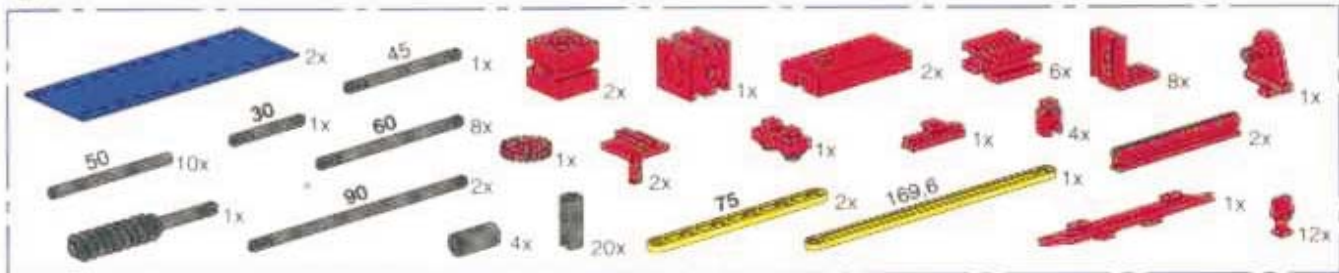

30mm 45mm 50mm 60mm 90mm

7

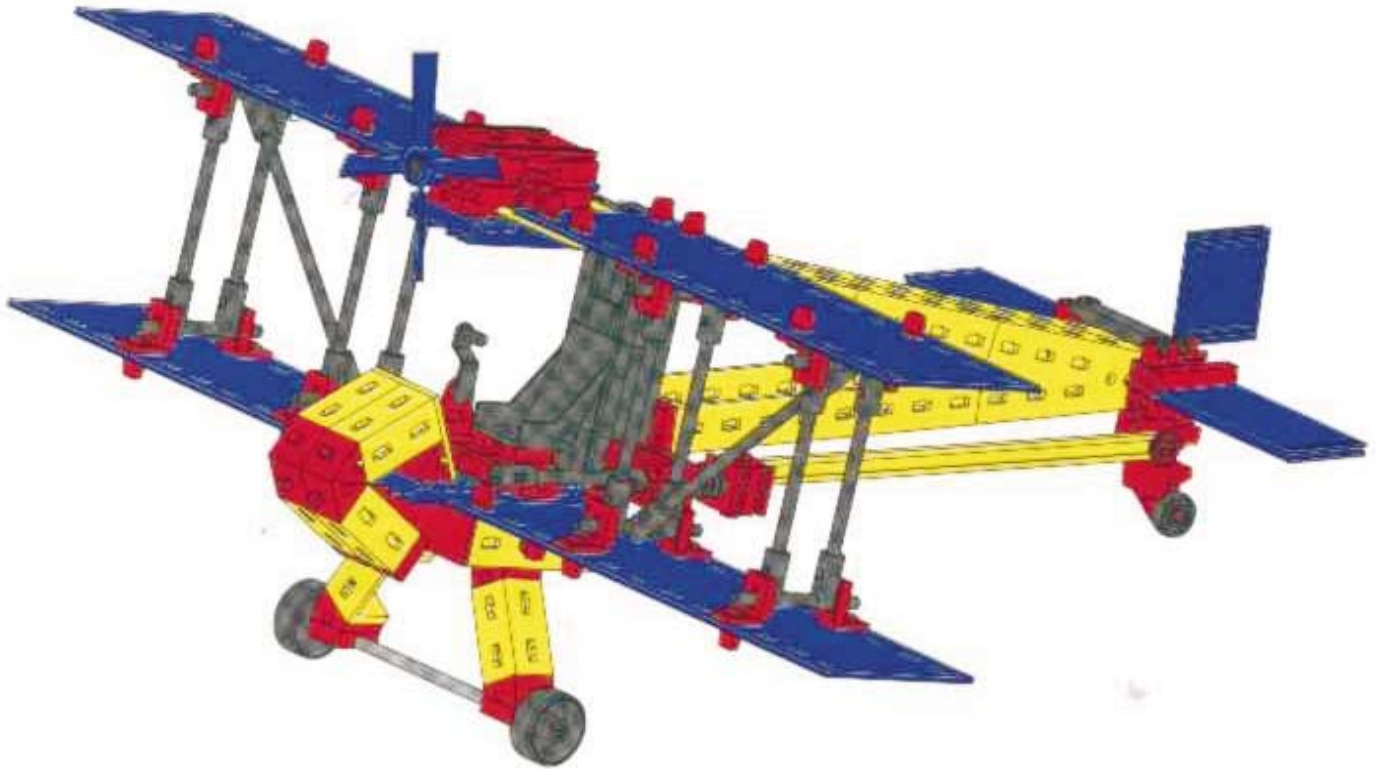
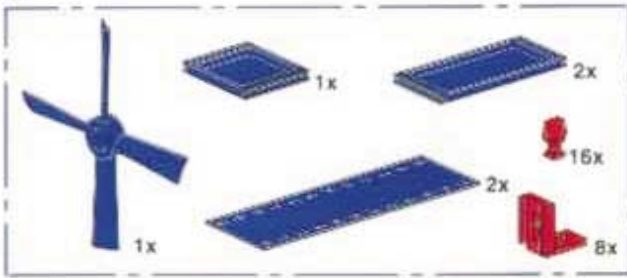

Seite 26
Page 26
Page 26
Bladzijde 26
Página 26
Pagina 26

Motorisierung
 Motor unit
 Motorisation

Motorisring
 Motorización
 Motorizzazione

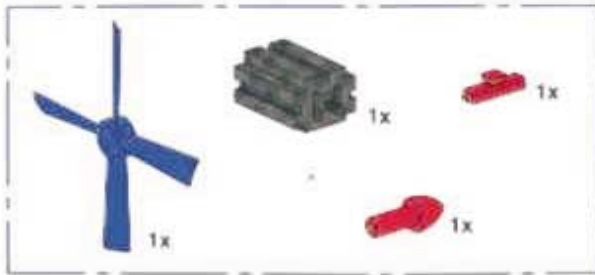

mit – with – avec
 met – con – con

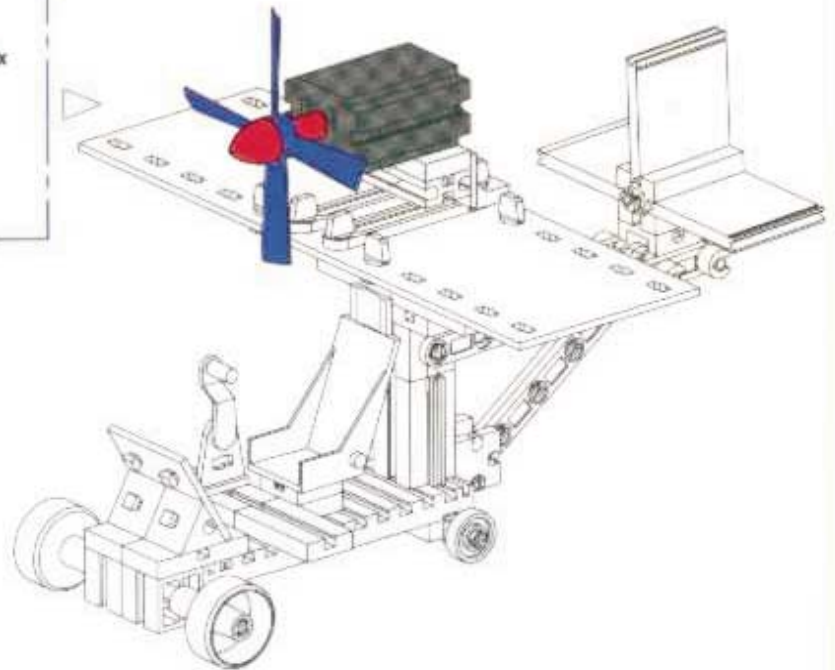
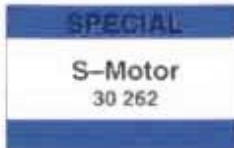

mit – with – avec
 met – con – con

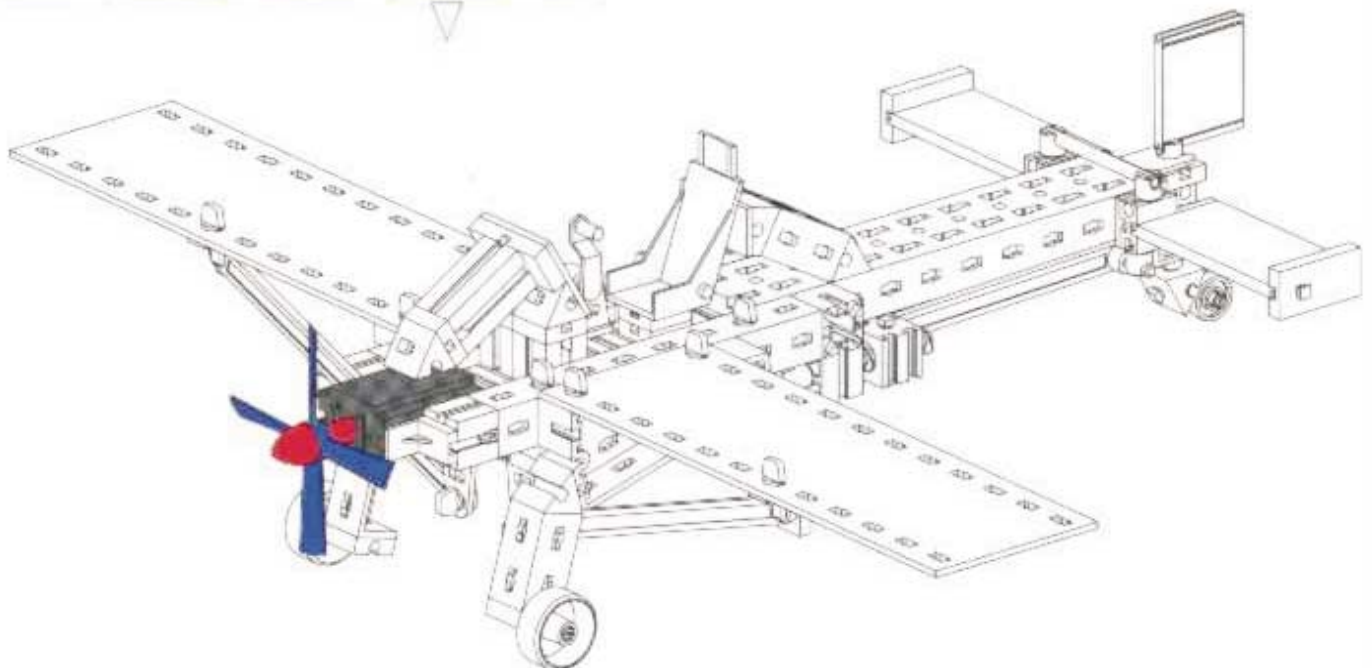
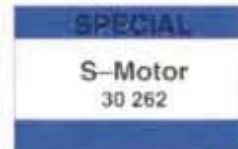

Motorisierung
 Motor unit
 Motorisation

Motorisring
 Motorización
 Motorizzazione

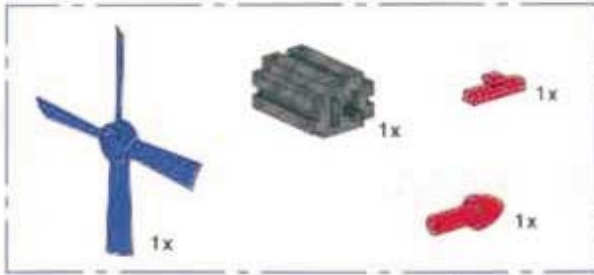

mit – with – avec
 met – con – con

SPECIAL
S-Motor
 30 262

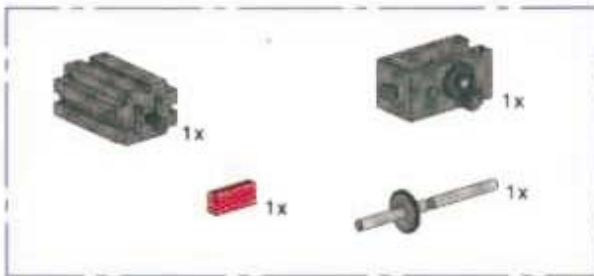
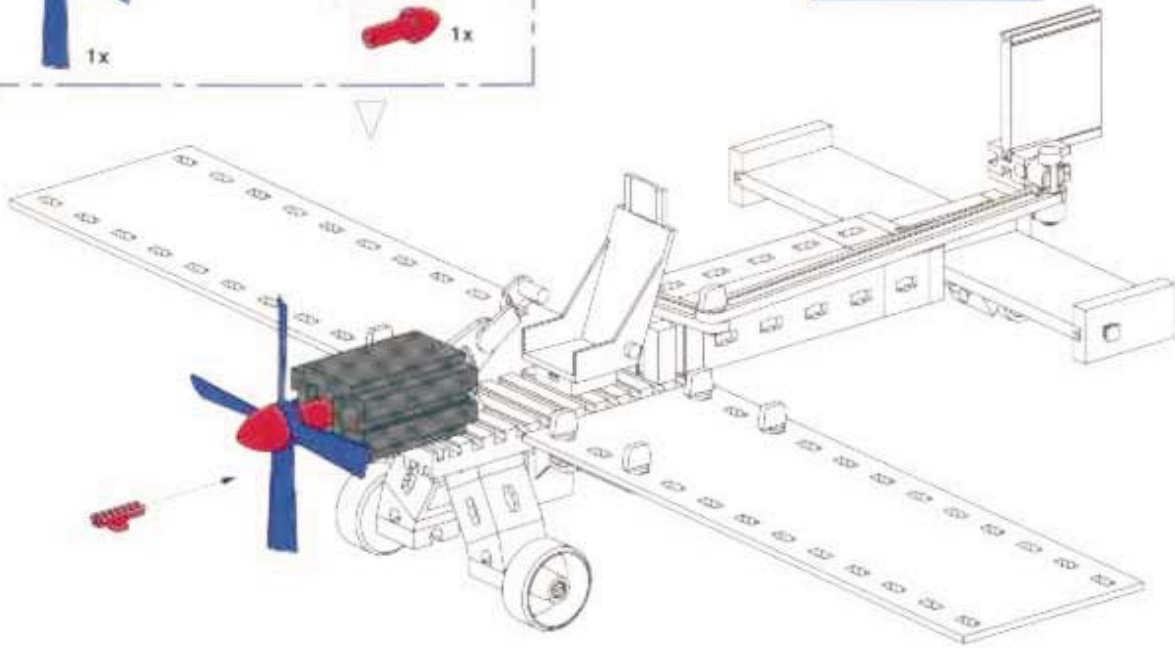

mit – with – avec
 met – con – con

SPECIAL
S-Motor
 30 262

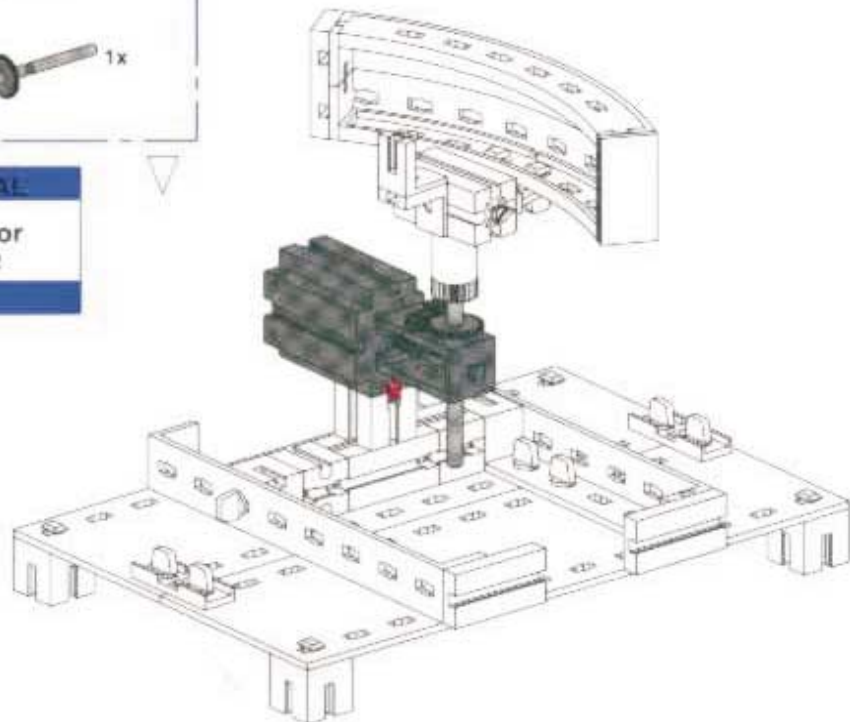

Motorisierung
Motor unit
Motorisation

Motorisring
Motorización
Motorizzazione

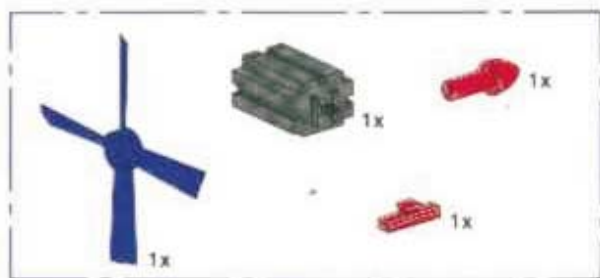

mit – with – avec
met – con – con

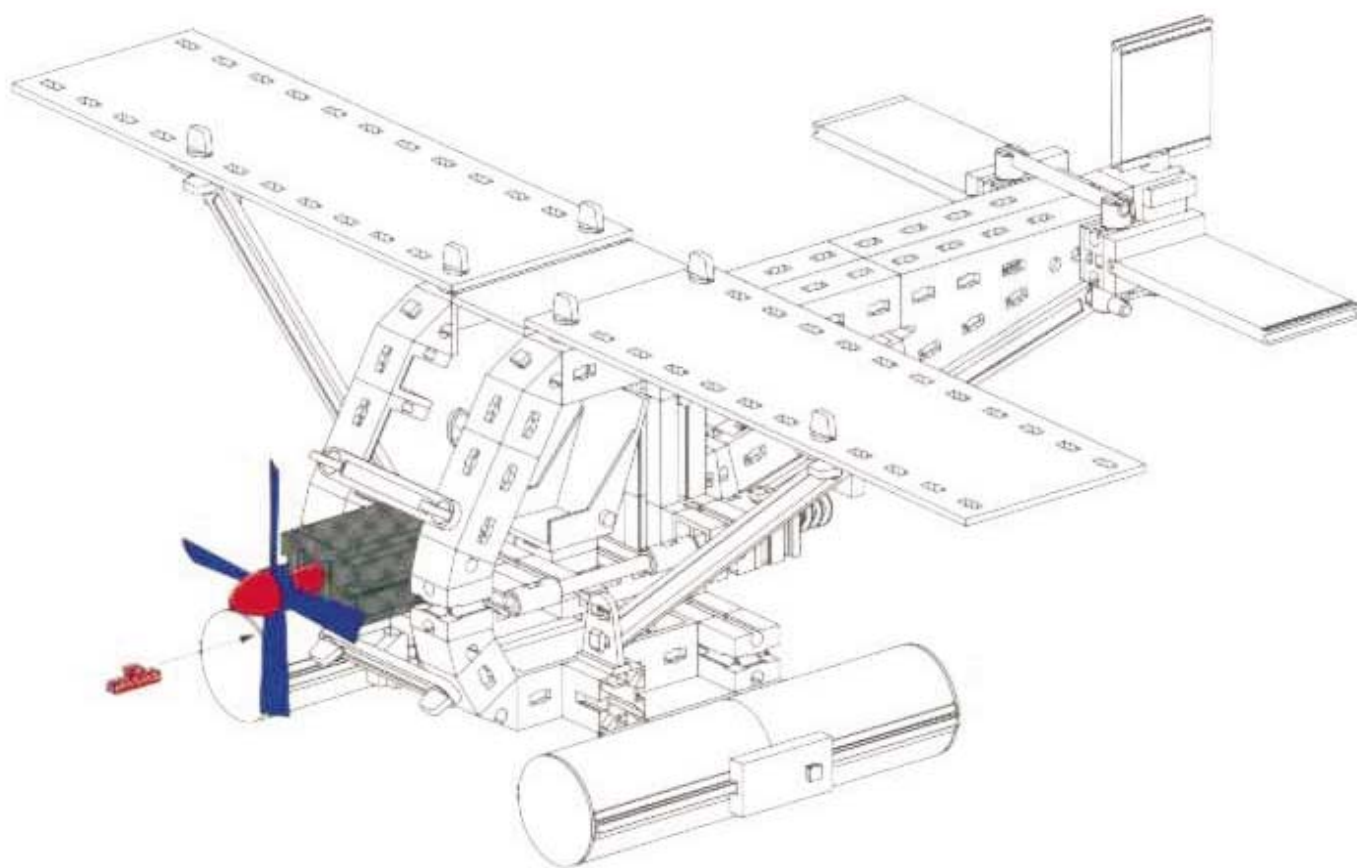
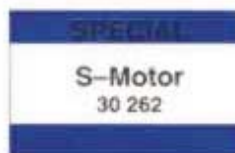

Motorisierung
 Motor unit
 Motorisation

Motorisring
 Motorización
 Motorizzazione



mit – with – avec
 met – con – con

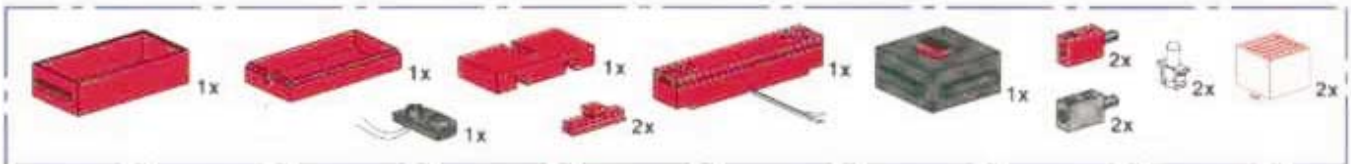
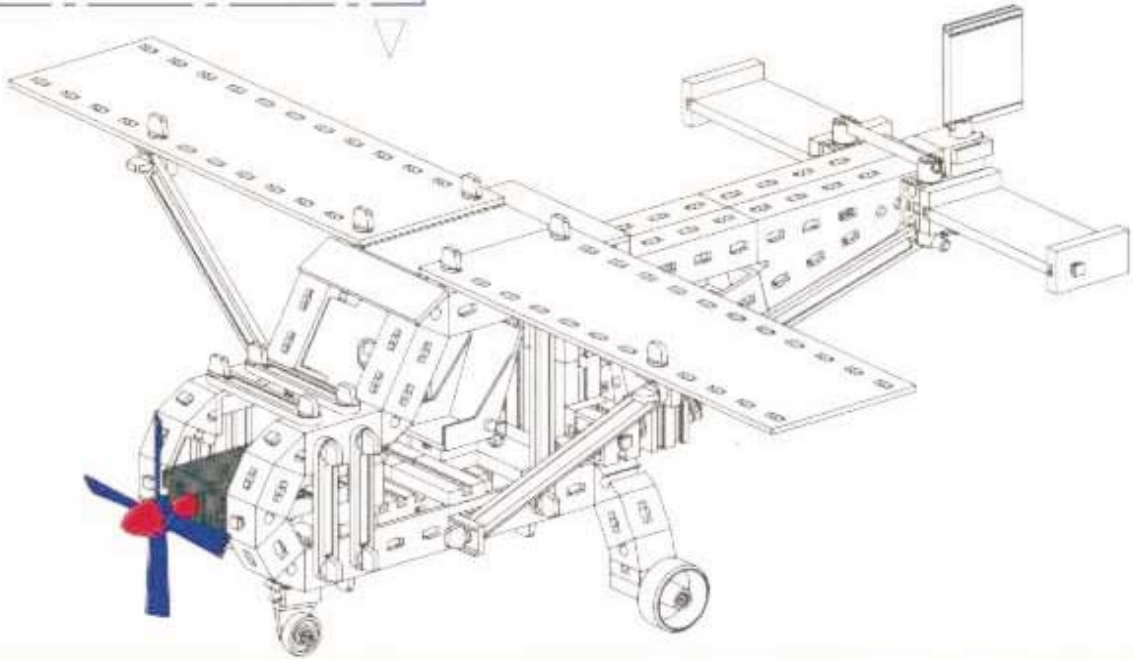

mit – with – avec
 met – con – con

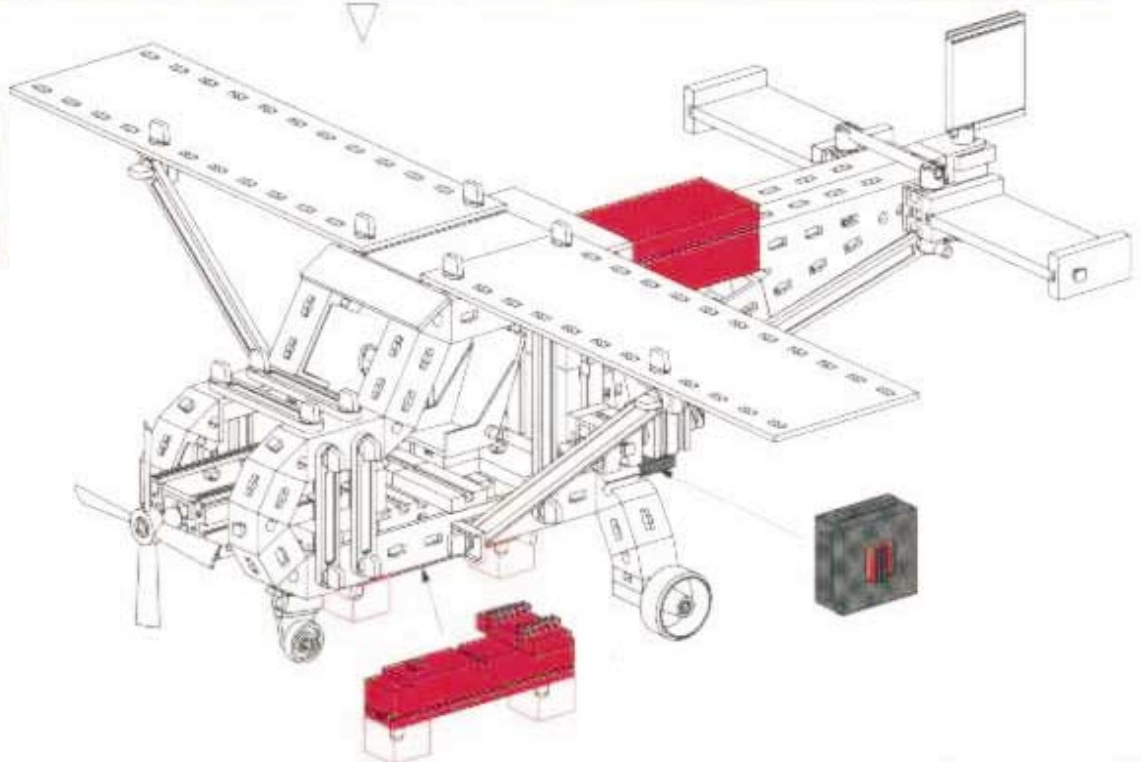



mit - with - avec
met - con - con

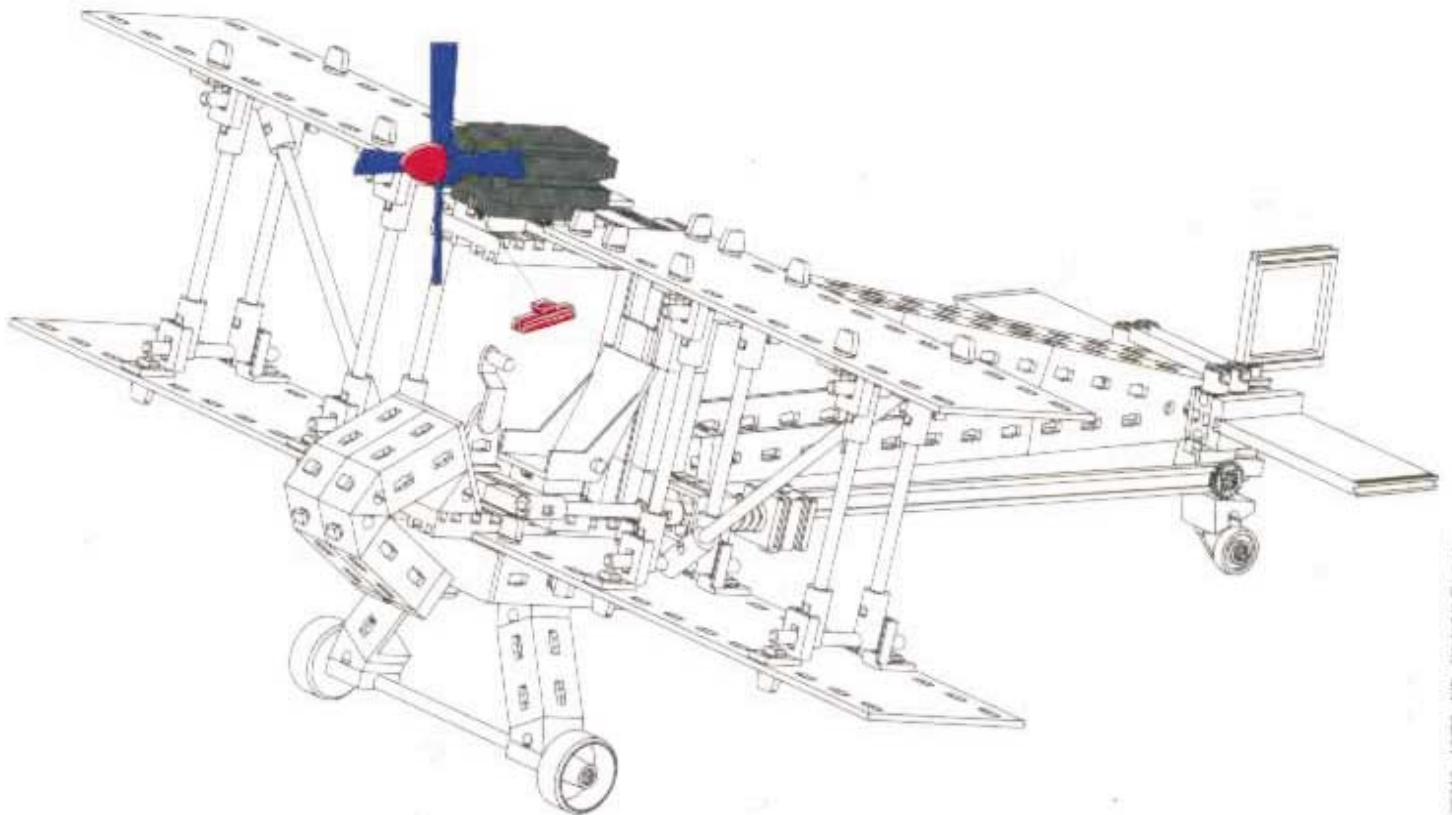
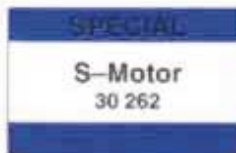

30343 - 1232 K/W - Printed in Germany
Technische Änderungen vorbehalten - Subject to technical modifications