

# fischer<sup>®</sup>technik<sup>®</sup>

## Bau-Spiel-Bahn

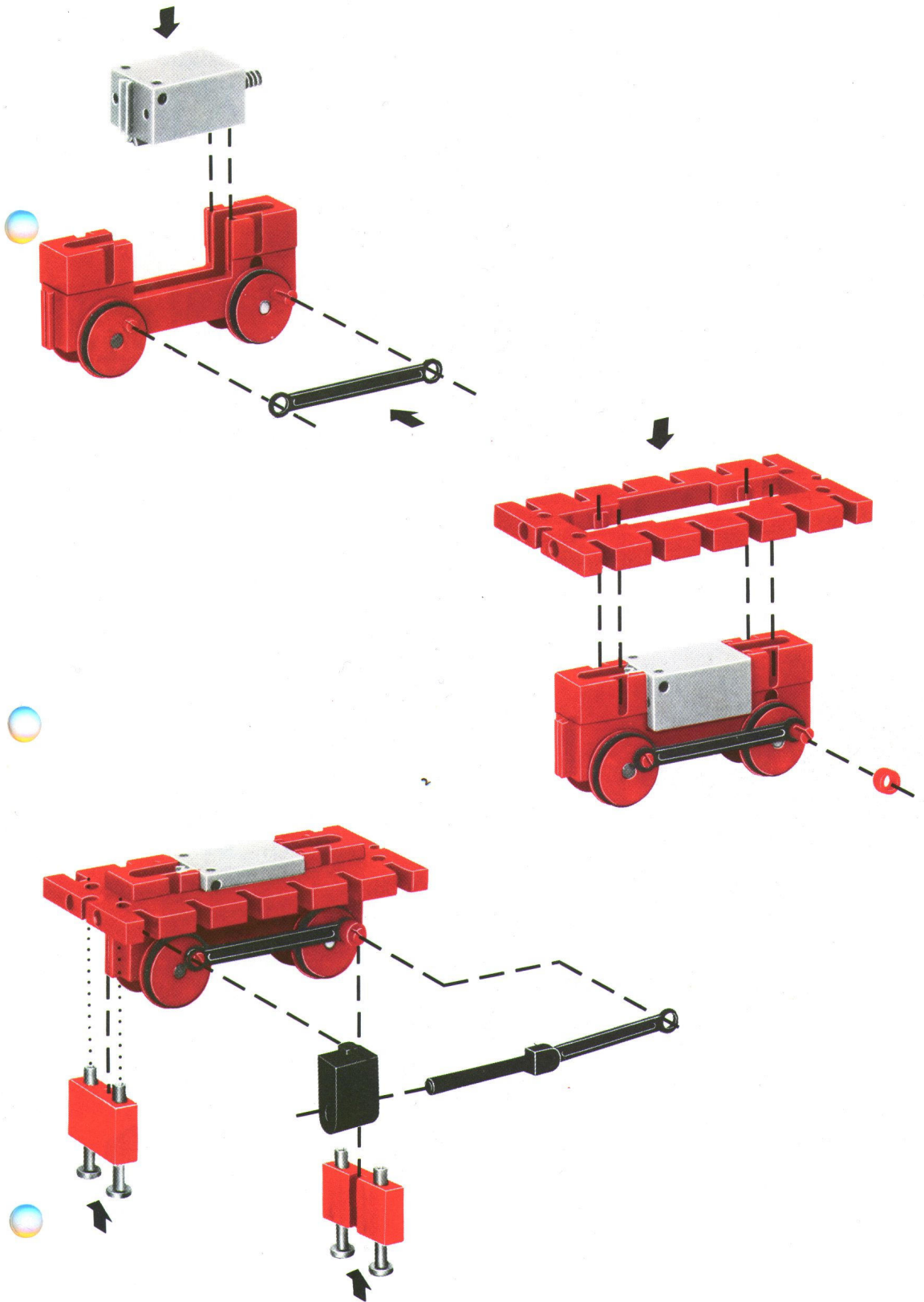





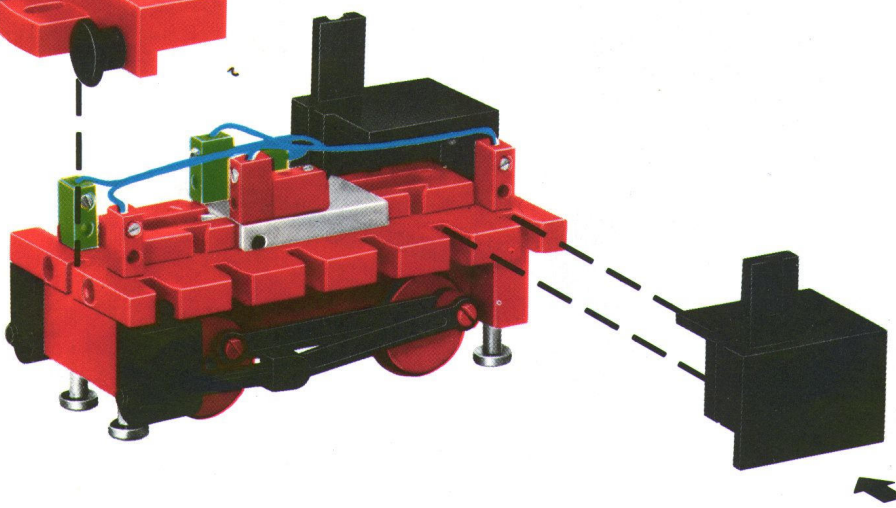
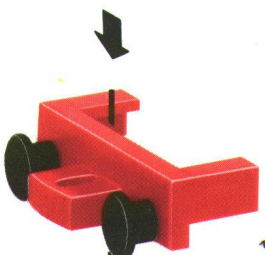
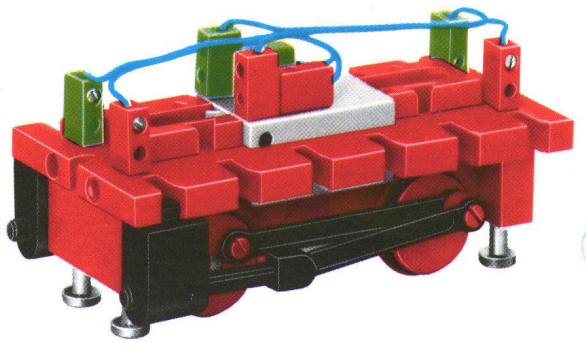
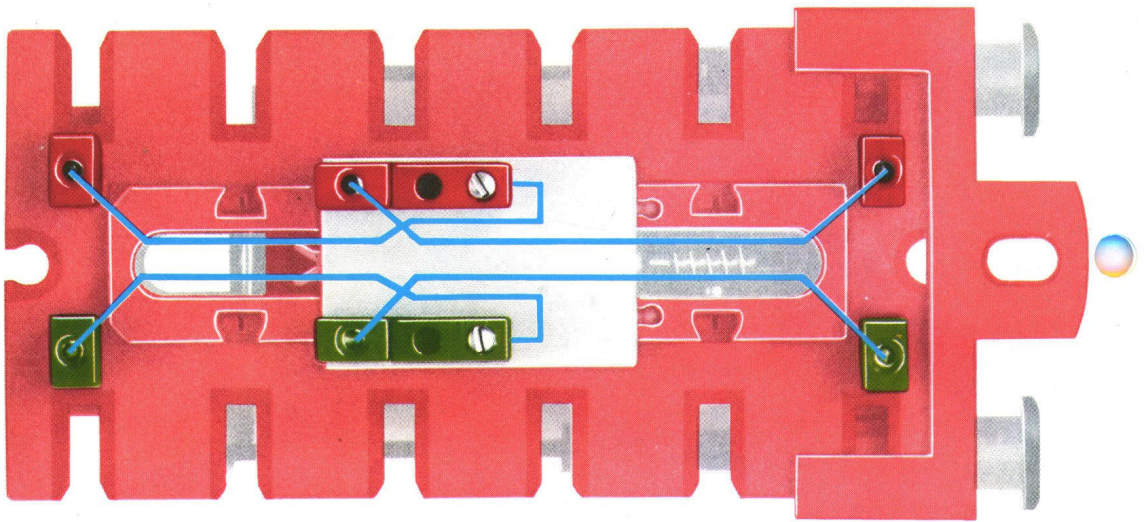

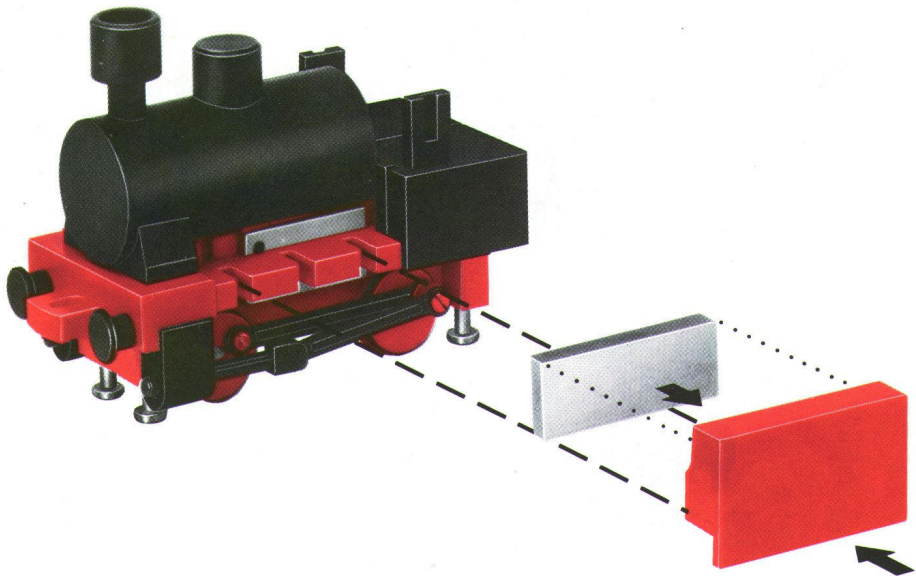
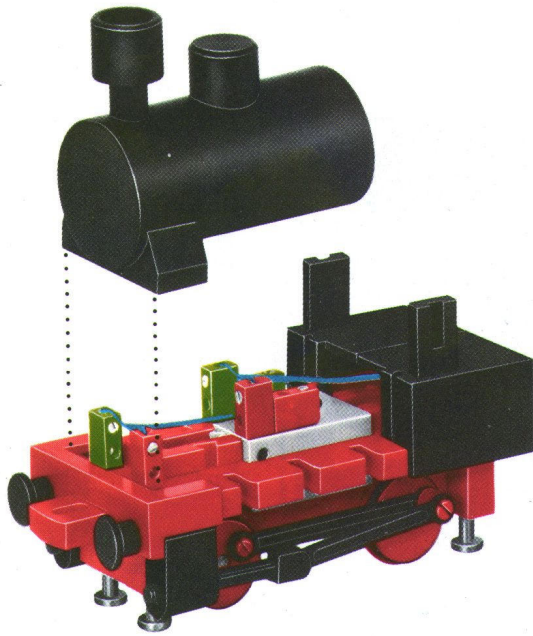

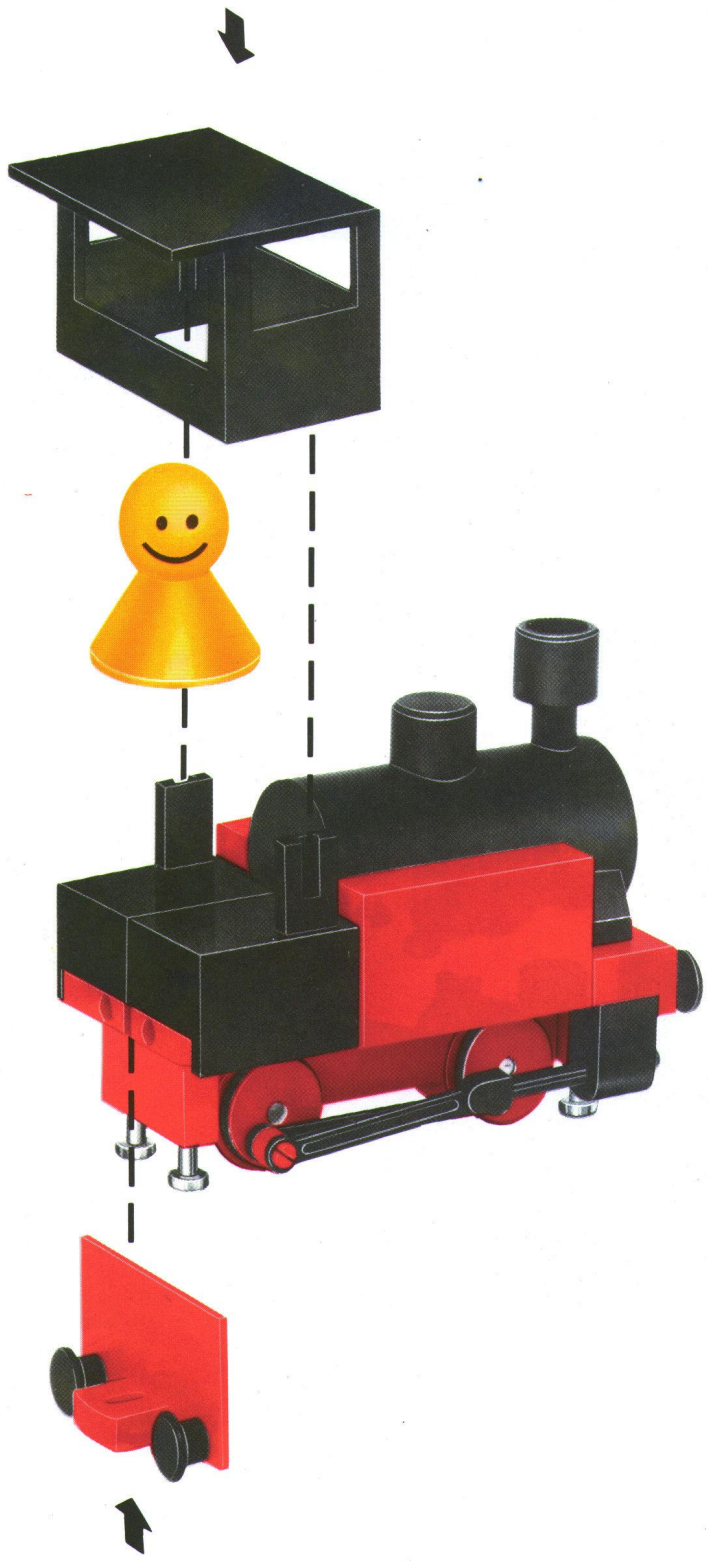

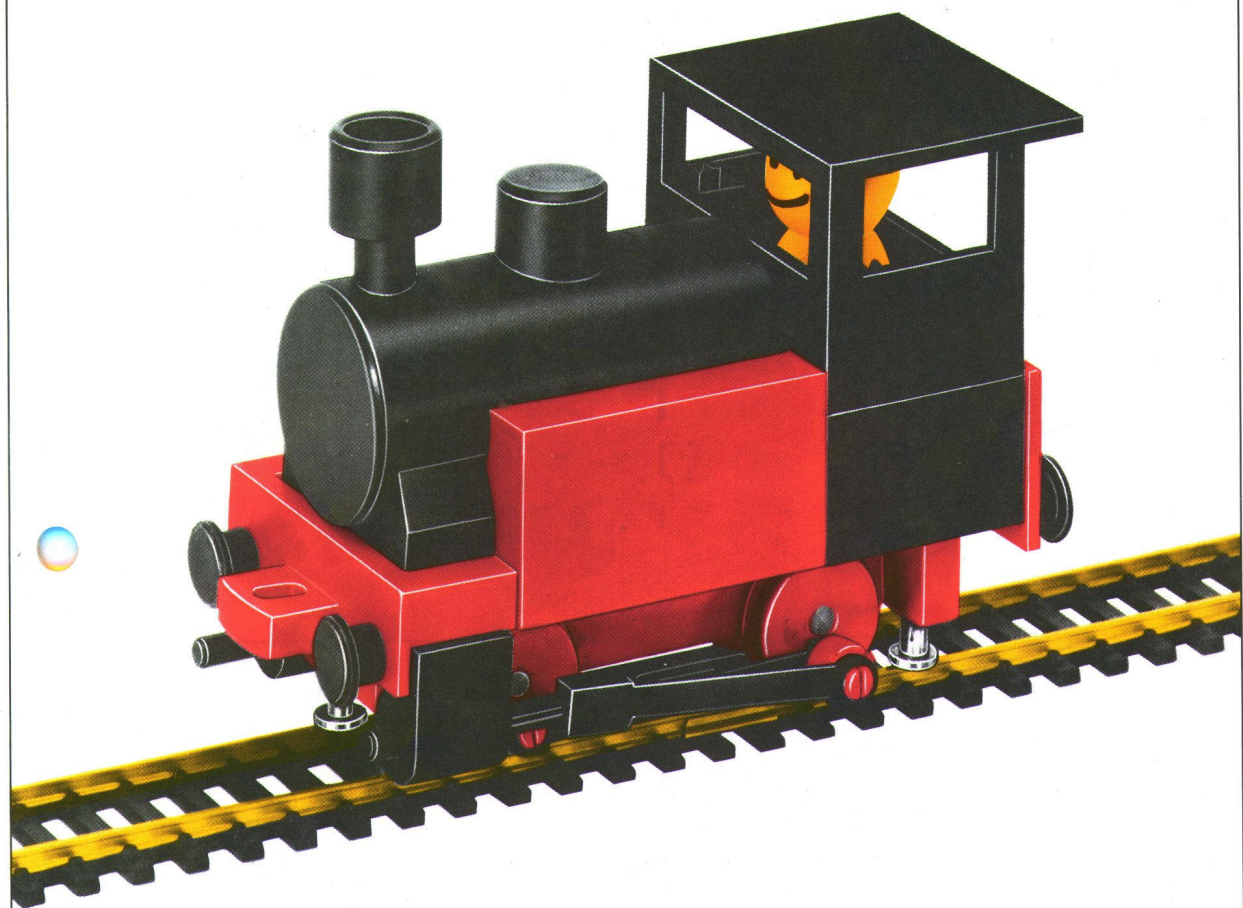

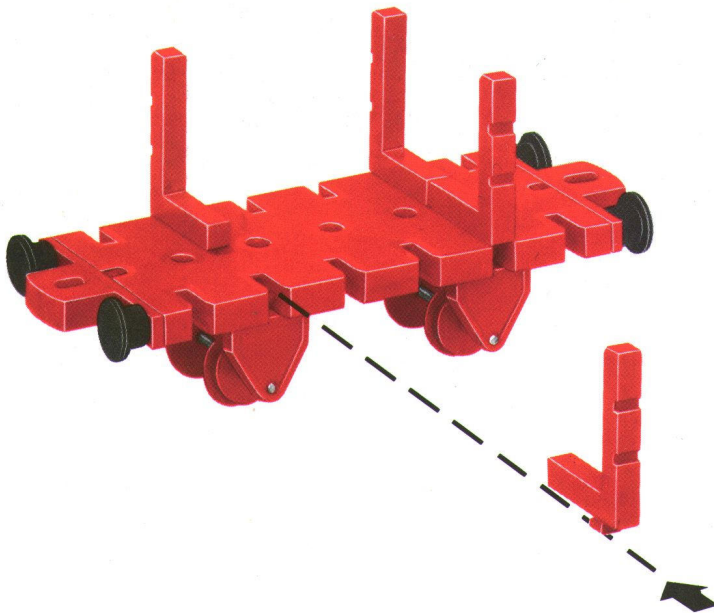
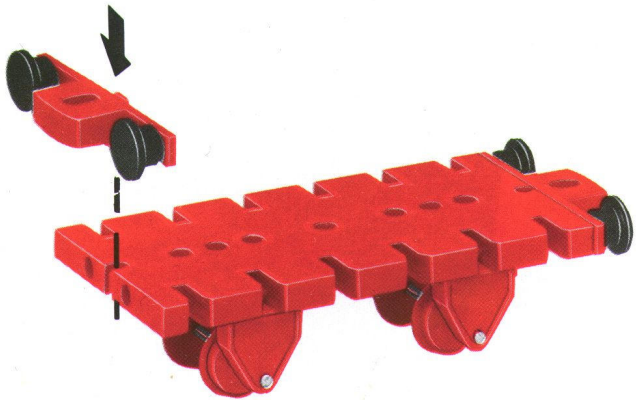
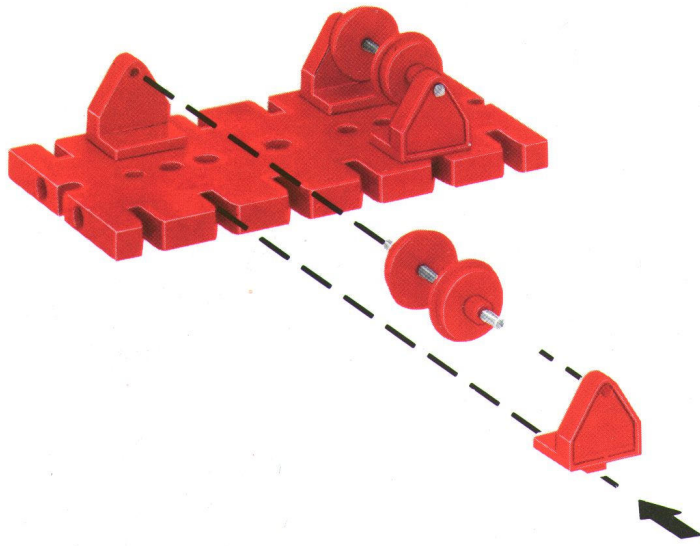



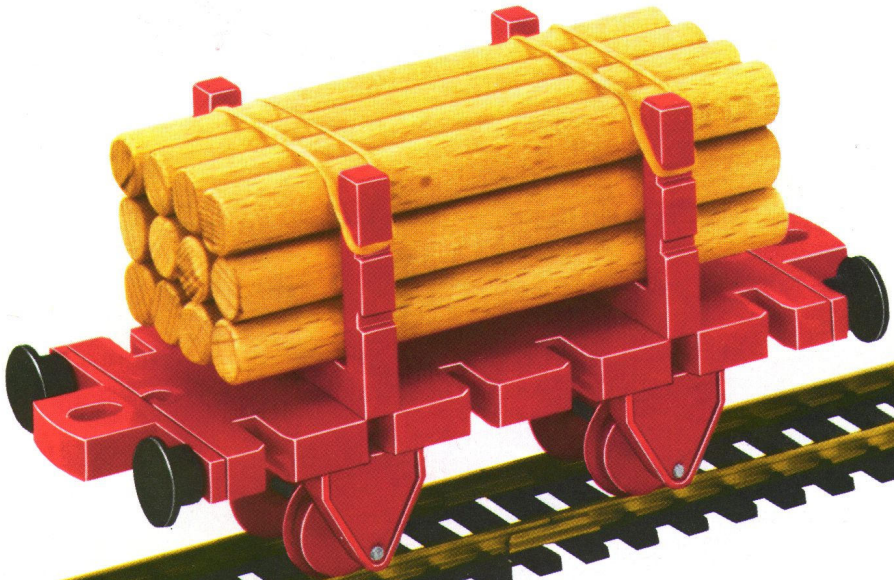
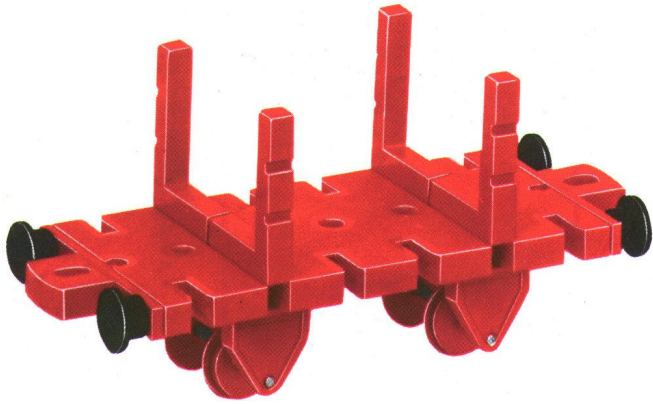

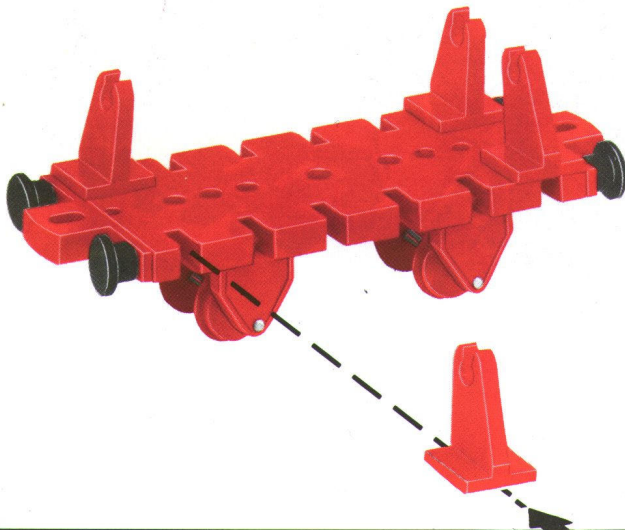
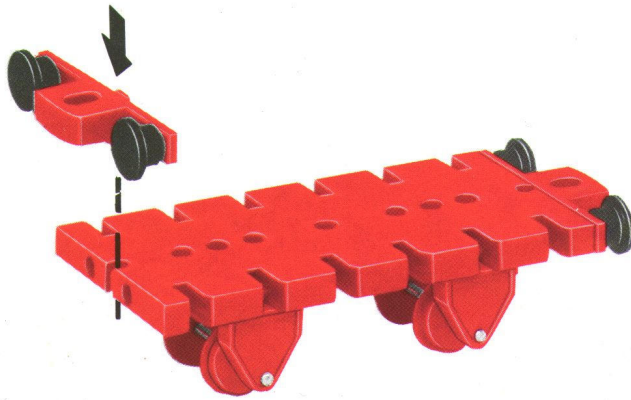
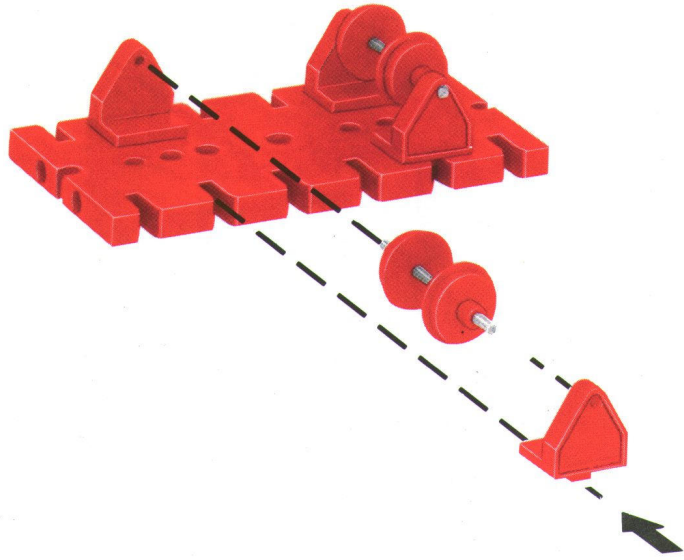

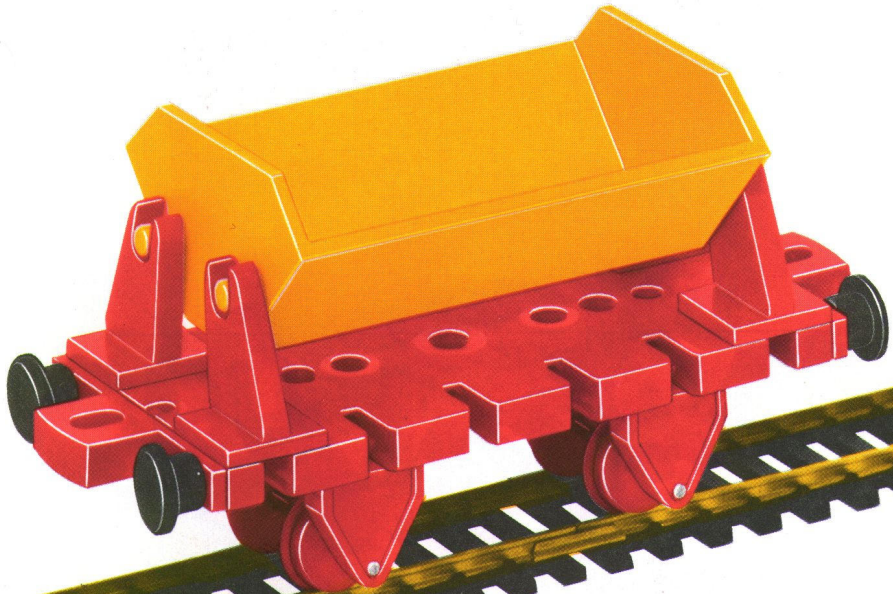
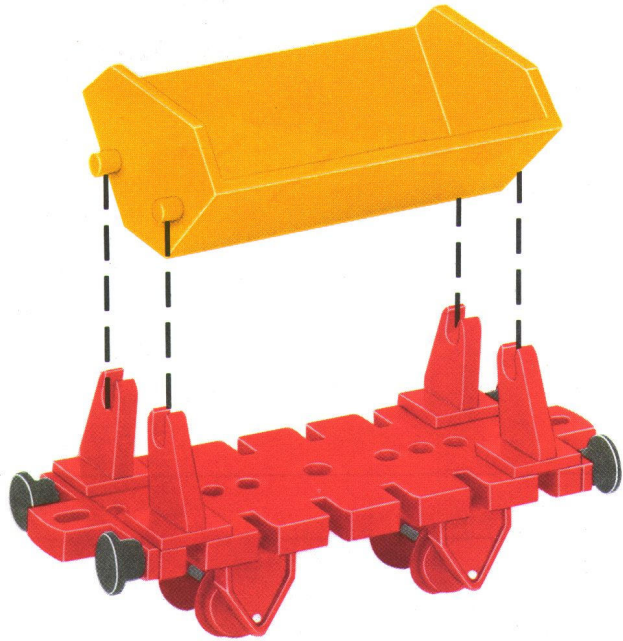

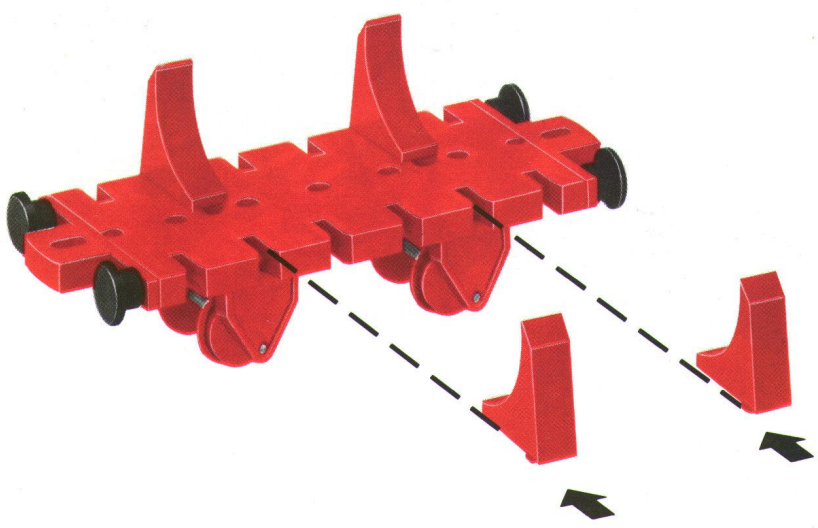
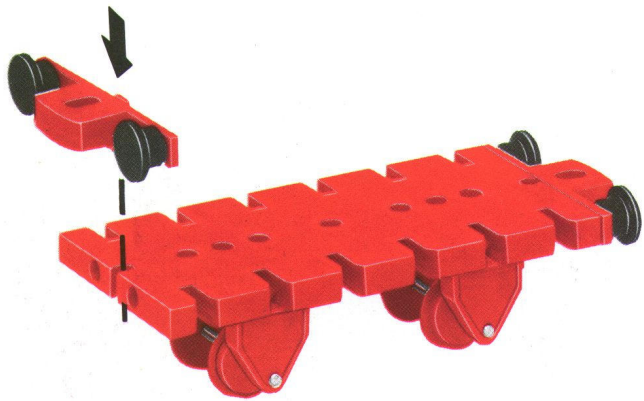
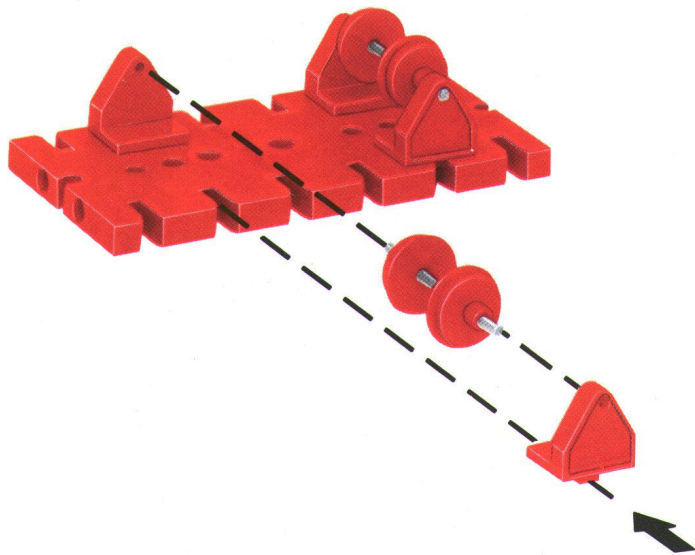

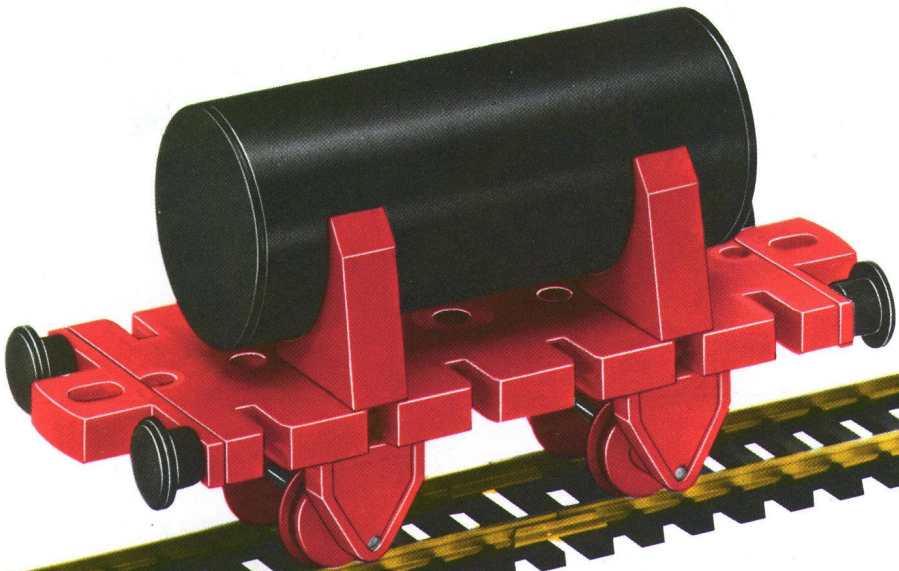
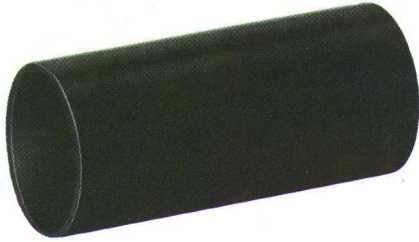

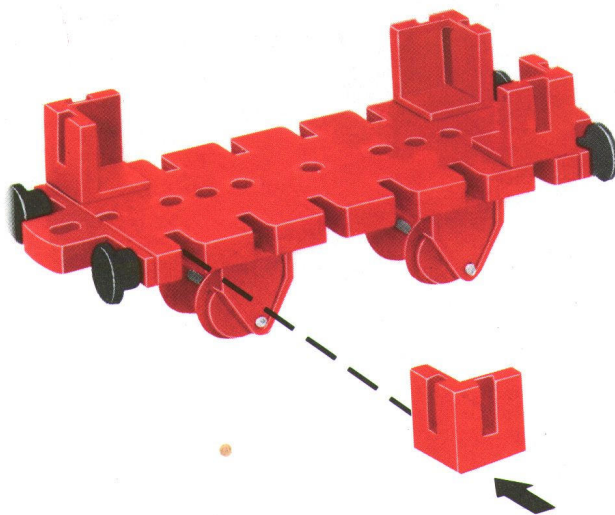
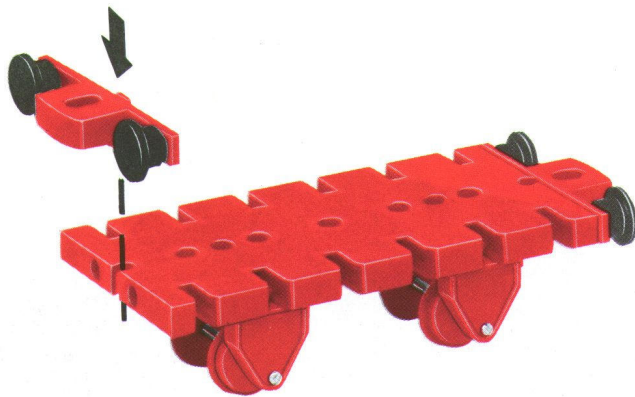
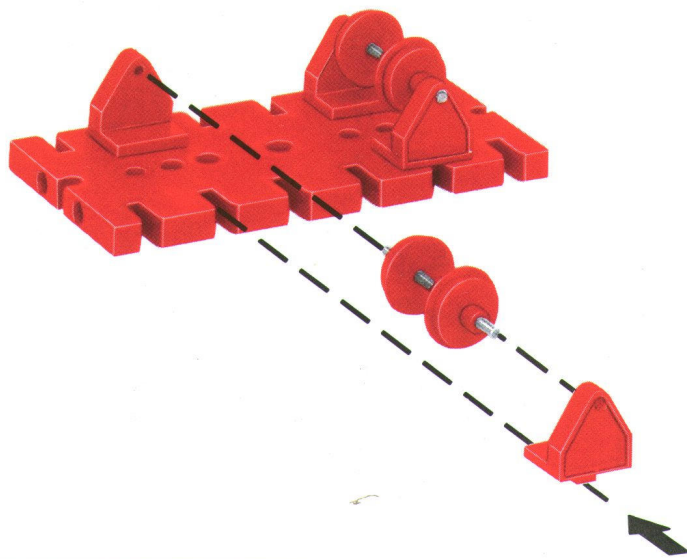

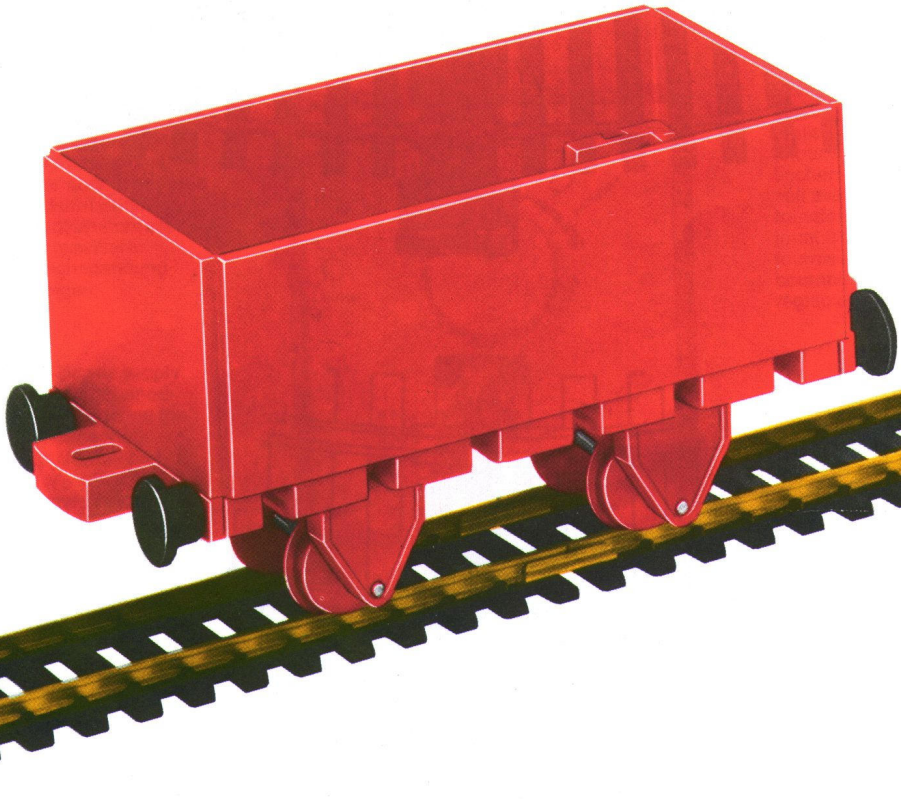
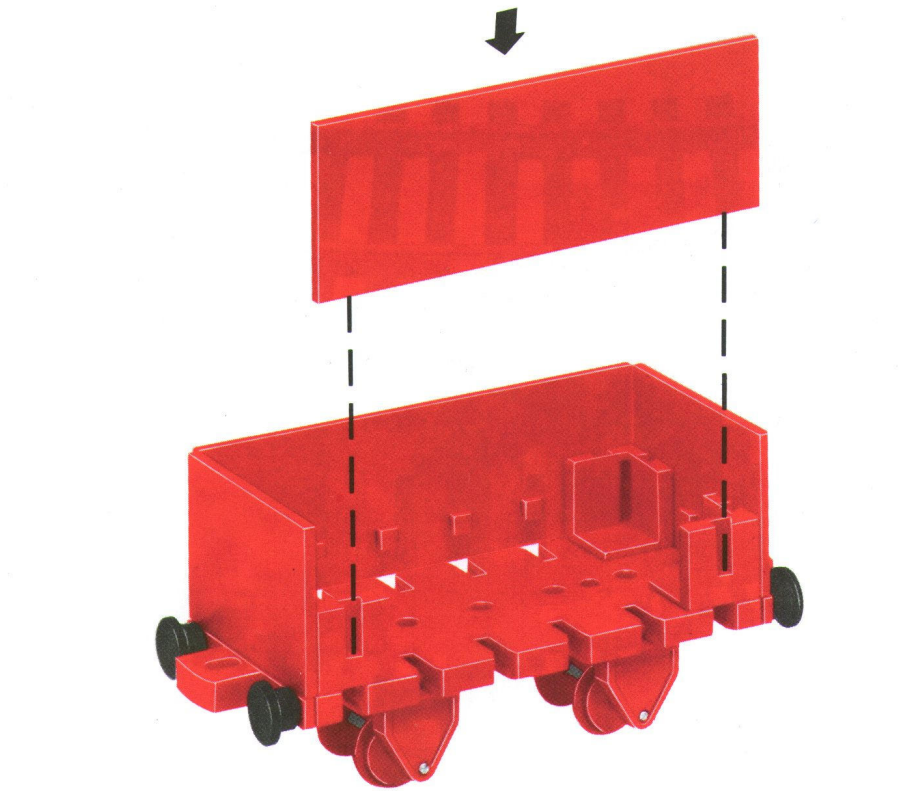

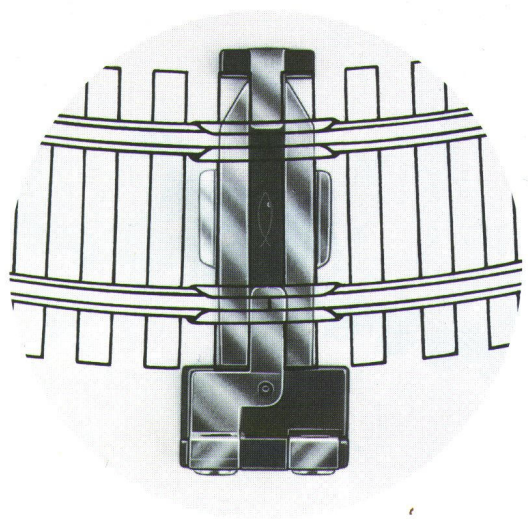
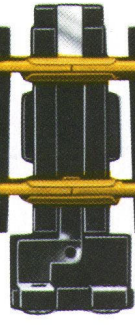
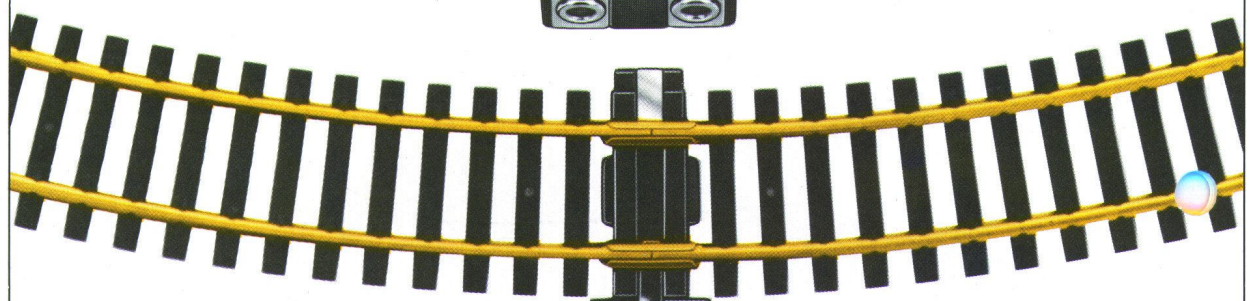
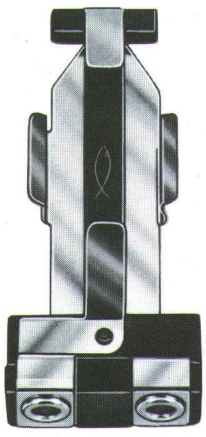
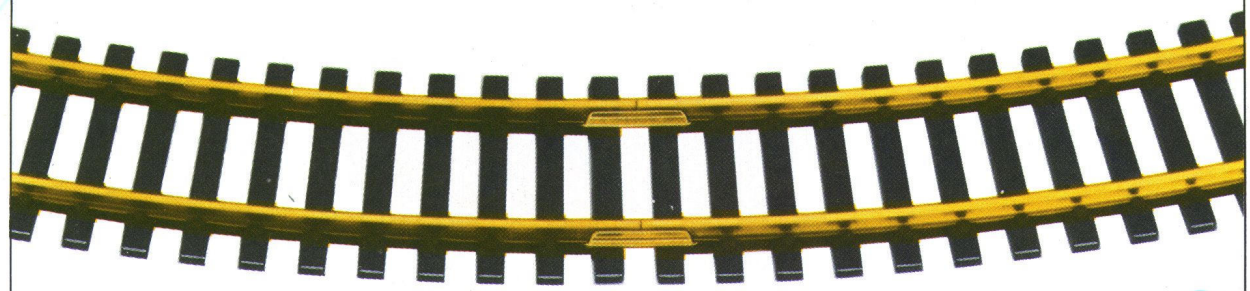



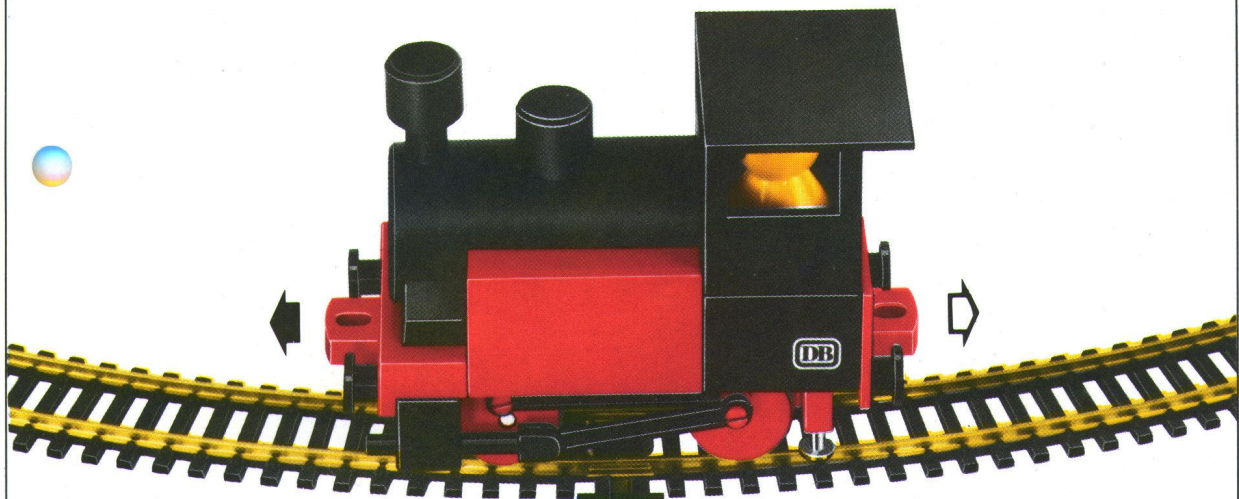

Die Stromversorgung kann entweder über das fischertechnik-Netzgerät mot. 4 oder aber über jeden anderen Spielzeugtransformator mit regelbarer Gleichspannung erfolgen.

The power supply may be obtained either by using the fischertechnik transformer mot. 4 or any other transformer designed for toys with an adjustable D.C. output.

L'alimentation électrique peut être réalisée soit avec le transformateur fischertechnik mot. 4 soit avec tout autre transformateur pour jouet électrique, fournissant du courant continu réglable.

De stroomvoorzorging kan zowel over de fischertechnik netspanning mot. 4 alsmede ook over elk andere speelgoedtransformator met regelbare gelijkspanning gebeuren.

