

## FAN-CLUB

# Nr. 20

ZUM SAMMELN!

## CLUBMODELL: „Kugelbahn“

Dieses Modell übt eine ungeahnte Faszination aus! Sicher werdet auch Ihr feststellen, dass man sich hiervon nur schwer lösen kann...

Die Tischtennisbälle sausen dynamisch die Bahn herunter, werden an der „Talstation“ sanft aufgenommen und wieder nach oben transportiert. Nach einer Weile spielt sich der Ablauf elegant ein. Ein echter Blickfang!

Die Kugelbahn besteht aus den Baukästen „Fun Park“ und „Universal“ (ggf. mit „Mini Motor Set“ zur Motorisierung) sowie folgenden Zusatzeilen, die nicht in den Baukästen enthalten sind: 2 x Art.-Nr. 37192 Förderglied und 1 x Art.-Nr. 32649 Beutel mit 152 Rastkettengliedern (die bekommt Ihr bei unserem Servicepartner Knobloch). Tja, und dann sind natürlich noch 3 bis 4 Tischtennisbälle aus dem örtlichen Sportgeschäft nötig, falls Ihr keine habt (Kosten: ca. 2 bis 3 Euro).

Wenn Ihr mögt und genügend Teile habt, könnt Ihr die Kugelbahn natürlich auch erweitern und weitere Kurven oder sogar Weichen mit separaten Schienen einbauen. Eure modifizierten Modelle könnt Ihr dann selbstverständlich auch an die auf Seite 2 beschriebene Galerie senden. Viel Spass!











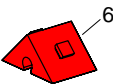

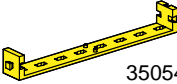

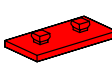

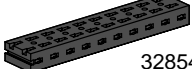

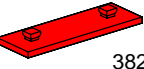

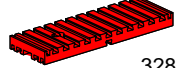

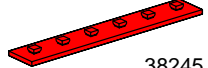

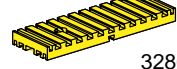



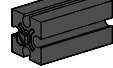

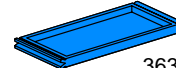
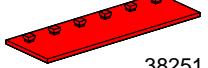
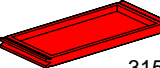
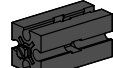

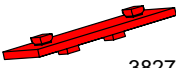











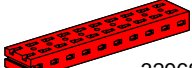
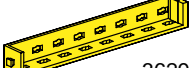

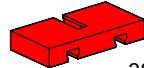

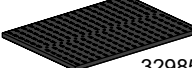
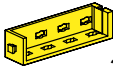

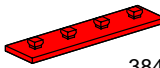

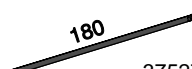

# fischertechnik®

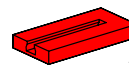
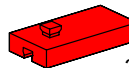





# Einzelteilübersicht

 31010	2x	 32850	12x	 35054	25x	 36324	18x	 38241	4x
 31021	2x	 32854	2x	 35058	19x	 36327	2x	 38242	3x
 31058	2x	 32859	2x	 35061	2x	 36328	2x	 38245	1x
 31060	10x	 32861	2x	 35062	2x	 36334	18x	 38246	4x
 31061	8x	 32879	13x	 35073	3x	 36342	4x	 38251	2x
 31555	5x	 32880	2x	 35076	6x	 36819	1x	 38277	2x
 31674	10x	 32881	25x	 35087	2x	 37192	2x	 38416	1x
 31981	10x	 32882	4x	 35088	1x	 37237	24x	 38423	22x
 31982	7x	 32968	4x	 36294	11x	 37238	4x	 38428	6x
 32064	7x	 32985	1x	 36297	25x	 37468	26x	 38464	2x
 32071	11x	 35031	2x	 36298	16x	 37527	1x	 38538	4x
 32330	2x	 35049	6x	 36299	13x	 37679	1x	 38544	19x
 32649	1x	 35053	12x	 36323	72x	 38240	2x		

## Motorisierung

1

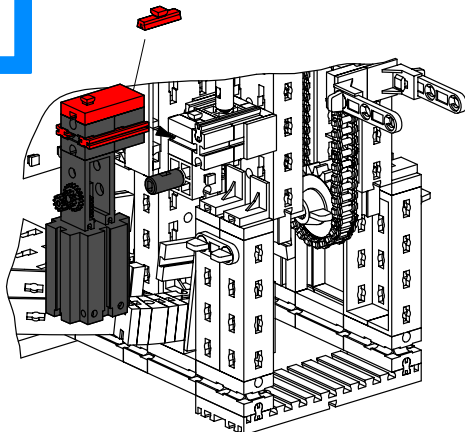

2

